

SECRET

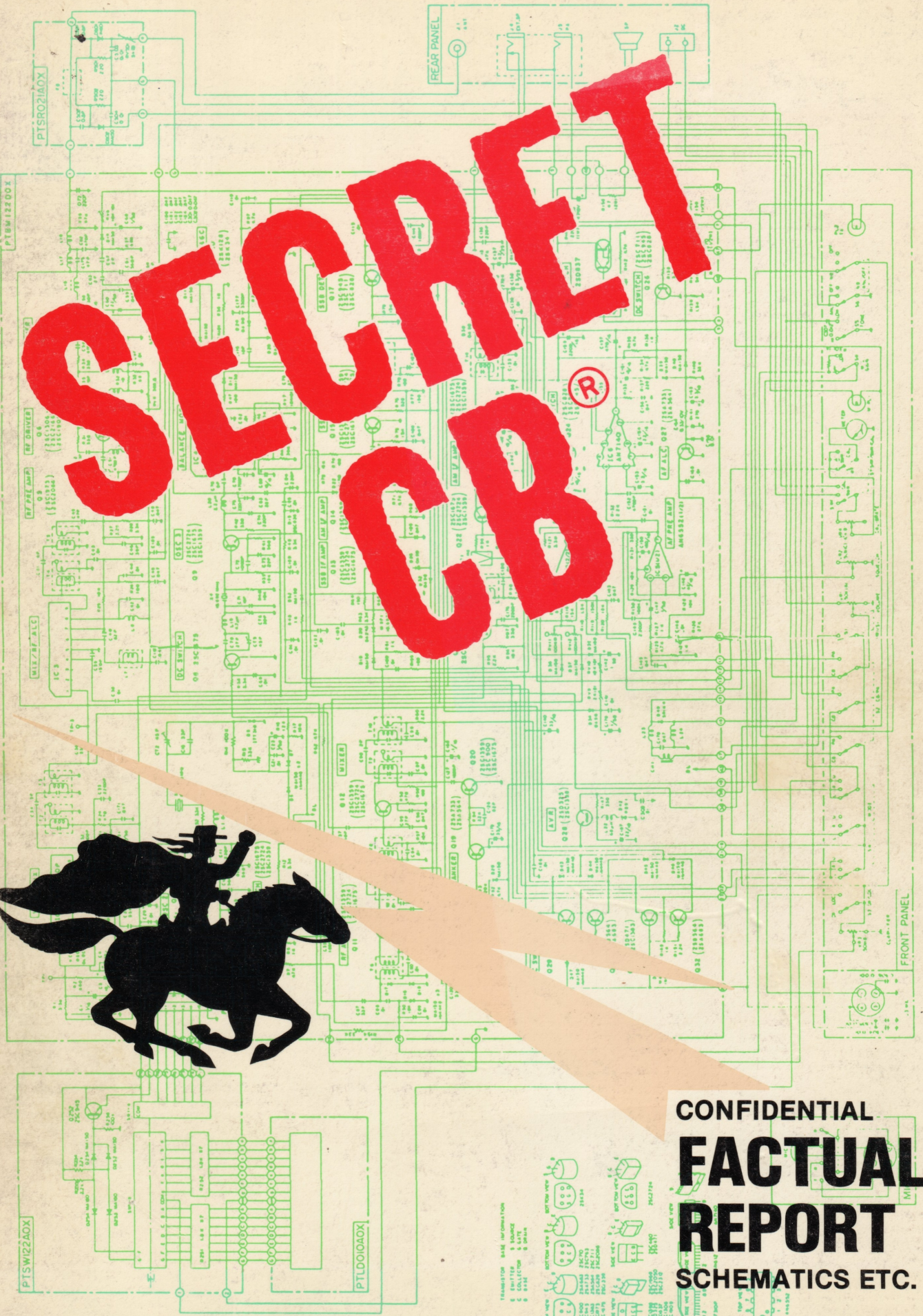
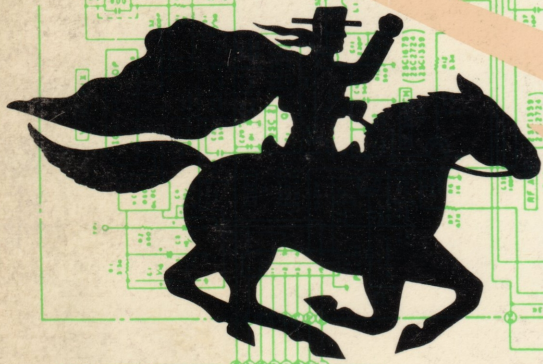

CONFIDENTIAL
FACTUAL
REPORT
SCHEMATICS ETC.

TRANSMITTER BASE INFORMATION

SWITCH & SOURCE

RECEIVER & SIGNAL

ANTENNA

GROUND

POWER

CONTROL

TEST POINT

REMARKS

DATE

BY

NO.

REV.

APP.

CHK.

DATE

BY

NO.

REV.

APP.

ACKNOWLEDGEMENTS

SECRET CB WISHES TO GRATEFULLY ACKNOWLEDGE THE FOLLOWING PEOPLE FOR THEIR HELP AND CONTRIBUTIONS TOWARD GETTING VOLUME 17 IN PRINT. THEIR ENCOURAGEMENT AND CONTRIBUTION OF MATERIAL HAS BEEN INVALUABLE.

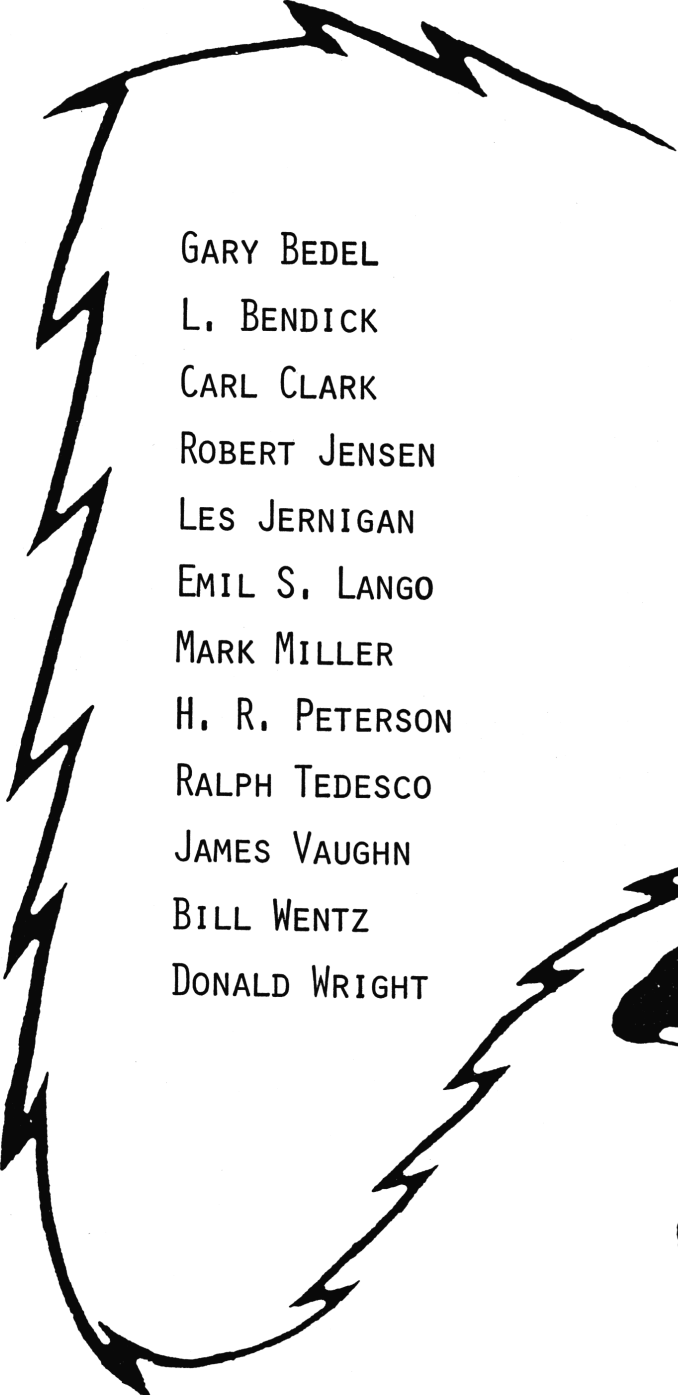

GARY BEDEL
L. BENDICK
CARL CLARK
ROBERT JENSEN
LES JERNIGAN
EMIL S. LANGO
MARK MILLER
H. R. PETERSON
RALPH TEDESCO
JAMES VAUGHN
BILL WENTZ
DONALD WRIGHT

WANTED

NEW MODIFICATIONS
NEW CONVERSIONS
TECHNICAL TIPS
PROJECT PLANS
ETC. ETC. ETC.



DORIS SAYS "THANKS" AND A FREE BOOK TO THE ABOVE PEOPLE.

INTRODUCTION

Thanks to my new Co-Author, William G. Wentz, Jr., we have another great volume of SECRET CB for you to enjoy. I am very grateful to Bill for sharing his knowledge with us and for his diligence in preparing this volume. Bill has surely saved SECRET CB from extinction. I am also grateful to all of our readers, especially those that have shared their knowledge and experiments with us. Without you we would not have this volume, and with your continued support we can keep going on & on & on.

We are trying very hard to keep up with new information and new ideas. And again we need your help with schematics and any new information you can pass on to us.

We now have some good instructions for installing SECRET CB Kit #27 into the Realistic TRC-490. We also have two kits that will fit the Stalker IX Export model, SECRET CB Kit #13 and Kit #33.

If you like to work CROSSWORD PUZZLES then you will want to turn to page 79 and get started on the one we have in this volume. Also, if you are one of the first ten to get it correct you will win one of our famous SUPER DIODES. All entries must be postmarked by December 31, 1983 and the answer will be published in SECRET CB Volume 18. We are planning to put a new puzzle in each volume if we get a good response from this one. So let us know if you like the idea.

We advertised in volume 16 about a Buy/Sell/Trade NEWSLETTER that we thought all of you readers would be interested in. We needed 100 subscribers to get it off the ground, but as of this writing we have not reached that figure. We are going to extend the subscription period up to the time we come out with SECRET CB Volume 18 which should be around the last of January 1984. If we have not reached the 100 mark by then we will abandon the idea. So let us hear from you!!!!!!

All of us here at SECRET CB want to wish all of our readers a VERY SPECIAL HAPPY HOLIDAY SEASON.

Until next time.....



Always Sincerely yours,

Doris
Doris Selman

TABLE OF CONTENTS

	PAGE #
ACKNOWLEDGEMENTS.....	1
INTRODUCTION.....	2
TABLE OF CONTENTS.....	3
"B" KIT BY CARD-KIT ELECTRONICS GENERAL INFORMATION.....	4-5
"B" KIT INSTALLATION INSTRUCTIONS:	
COBRA 19XS, MIDLAND 103M, COLT 355.....	6-7
COBRA 20LTD.....	8-9
COBRA 21GTL & LTD, 25GTL & LTD, PRESIDENT AR44 & AX44, AR711 & AX711, PRESIDENT ANDREW J.	10-11
COBRA 29GTL & LTD.....	12-13
COBRA 19X, COLT 210, GE 3-5805B, MAXCOM 4A, MIDLAND 100M, 102M, 150M, 151M, 800M, 2001, 3001, 4001.....	14-15
MIDLAND 200M.....	16-17
MIDLAND 77-824B, REALISTIC TRC-427.....	18-19
GE 3-5804F, PRESIDENT AR-7.....	10-21
K-40's K-401.....	22-23
PRESIDENT AX-11.....	24-25
PRESIDENT JAMES K.....	26-27
PRESIDENT "OLD HICKORY".....	28-29
REALISTIC TRC-425.....	30-31
REALISTIC TRC-426.....	32-33
SPECIFIC TUNE-UPS: REALISTIC TRC-211 & 212.....	34
MECTRON ME-400 CONVERSION.....	34
TRISTAR 747 - SLIDE MODIFICATION.....	34 35
COBRA 25LTD (UPDATE) - MORE POWER/MODULATION.....	35
SECRET CB KIT #106 INSTALLATION INSTRUCTION FOR TRC-451.	36-38
M58472P PLL CHIP (UPDATE).....	39
FORGOTTEN ACCIDENT.....	39
COBRA 148GTL-B (EXPORT).....	40-42
COBRA 148GTL-B SCHEMATIC.....	43
PALOMAR 2400 SCHEMATIC.....	44
COLT510/COMMTRON XII SCHEMATIC.....	45
HINTS / KINKS / GOOFS.....	46
COBRA 148GTL-DX (EARLY-LATE) FACTS.....	47
YOU CAN BUILD - BURGLAR ALARM.....	48
YOU CAN BUILD - CUSTOM REGULATED POWER SUPPLY.....	49-50
GYPSY FREQUENCY CHART & "KIT" INFORMATION.....	51-52
TRAM D201/201A SERVICE NOTES.....	53
TRAM XLR 23 Ch. SSB SLIDE MOD.....	53
COBRA 148GTL-DX (LATE) UPDATE.....	54
TRC-448 'EXPANDED SLIDE' UPDATE.....	54
COBRA 148GTL-DX (LATE) ALIGNMENT PROCEDURES.....	55-58
SPECIFIC TUNE-UPS: GEMTRONICS GTX-3323 & MIDLAND 102M..	59
PLL CHIP INFORMATION.....	59
PACE 8010/8015 (MM55107 - PLL) MODIFICATION.....	60-61
REALISTIC PRO-54 SCANNER (D.C. MOD.).....	62-64
VIDEO "DUBBING/COPYING" TIPS.....	64-65
SPECIFIC TUNE-UPS: SEARS 934.38060700 (PLL 861).....	65
SPECIFIC TUNE-UPS: MIDLAND 1001 (77-001) & 103M (77-103)	65
VCR VIDEO MODIFICATION - TRS-80 12" VIDEO DISPLAY.....	66-69
!OOP'S, WE GOOFED!: V. 4, P. 54 - O2A CHIP INFO.....	70
V. 15, P. 58 - TRISTAR 747.....	70
V. 16, P. 50 - 148GTL-DX (EARLY)....	70
V. 16, P. 72 - RAY JEFFERSON.....	70
SECRET CB INDEX FOR VOLUMES 1 THRU 16.....	71-78
!OOP's WE GOOFED! INDEX.....	78
CROSSWORD PUZZLE.....	79

"B" KIT by CARD-KIT ELECTRONICS

READ the article; all F ϕ 's are in MHz-unless otherwise noted...

As stated in the announcement (Vol. 16, pg. 8) the principles used in the development of the "B" Kit are quite simple. All PLL Chips using a .455 off-set shift, can be reversed in their shifting direction.

The VCO output is normally used during receive as the Local Oscillator (L.O.) Frequency. During transmit it is shifted up by .455 and combined with the Reference Oscillator Frequency (Ref. F) of 10.24, to generate the Transmitter Frequency (TX-F).

During receive the L.O. Freq. is beat with the incoming RF signal which creates the 1st Intermediate Frequency (IF) 10.695... This 1st IF is then beat with the Ref. F. (10.24) to create the 2nd IF of .455... The 2nd IF is then rectified/detected and the .455 is filtered out to create the Audio Frequency (AF)...

However, there is a second frequency that can be received that if it is allowed to combine with the Ref. F will also create a 2nd IF of .455... This frequency is referred to as the Anti-Image Frequency.

This is what occurs: Symbol-)(, = Mixed or Combined with..
IMAGE..... 27.075)(16.380 = 10.695)(10.24 = 455KHz
ANTI-IMAGE.... 26.165)(16.380 = 9.785)(10.24 = 455KHz

The Anti-Image is prevented from entering the 2nd Mixer Stage by a ceramic or crystal filter. This filter passes the 10.695 and blocks the 9.785...

Now, if we change the direction of shift on the PLL Chip, the L.O. is 455KHz higher than normal during receive. Transmit is 455KHz lower than normal.

Example: 27.075 (Ch-10) becomes 26.620 TX-F ϕ .

During receive the VCO Output of L.O. Frequency 16.380 becomes 16.835... Now to look at it graphically...

IMAGE..... 27.530)(16.835 = 10.695)(10.24 = 455KHz
ANTI-IMAGE.... 26.620)(16.835 = 9.785)(10.24 = 455KHz

Now the Anti-Image becomes desirable and the Image is undesirable frequency. Since the 1st IF of 9.785 is blocked by the 10.7 ceramic filter, it must be replaced.

The above information is strictly to remove any mystery about what the "B Kit" is designed to accomplish. Namely to reverse the direction of PLL shift and switch filters.

At present, there is one other requirement needed within the unit to be modified, besides having a 455KHz offset shift. The unit must also have a tuning tank preceding the ceramic filter. This requirement will hopefully be eliminated in the future, and add more units to list of those modifiable.

This change to the "B Kit" has already been tested. Delay is getting the necessary components to replace the filters.

Additional units made possible to modify by the component change will be featured in up-coming volumes of "Secret CB".

Order your kit from Selman Enterprises - ask for Kit #136"B".

"B Kit" (Cont.)

GENERAL INSTRUCTIONS:

Before starting your modification you should decide if you wish to make a straight installation, which gives frequencies 26.510 thru 26.950 in 10KHz steps. Or to be compatible with older sets and have 26.515 thru 26.955 also. All that is needed is to install the SPDT switch provided or mount the variable capacitor on one of the existing switches.

If you do not wish the 26.515 thru 26.955, omit all instructions under 5KHz OFFSET and do CHANNEL CONVERSION only.

How to make up the SPDT switch is illustrated in "Secret CB"; Vol-14, Pg. 21... "B Kit" will use both a new switch and capacitor; Capacitor is smaller in size, but same value; Switch now has only two terminals. ...When making up the switch it is advisable to first solder wires to it, then solder the capacitor...

EQUIPMENT REQUIRED:

As written these modifications call for a Counter and Signal Generator. We realize that many persons don't own a Sig. Gen. but there is an alternative.

Instead of modifying one unit, do two at the same time! Make the complete installation in both units except the receiver tuning. (Use one of the units as a Sig. Gen. as you calibrated it with Counter). Put one on a separate power supply, set at a distance from the other. Install a 50 ohm, 4W dummy load, avail. at R/S., and there is your Sig. Gen...Key it up and do your alignment on the other, then reverse units.. Note: Turn volume down on the receiving unit to prevent feedback.

MOUNTING HINTS:

1. Since extra space is almost non-existent in the smaller units it is difficult to mount any kit. But usually in most units just above the PLL Chip on the chassis there is sufficient space to mount the epoxy pack of the "B Kit". If you wish to add the 5K OFFSET; may have to use an existing switch (NB, etc.); or use SPDT switch provided.
2. When mounting the Epoxy pack leave the washer on the inside of the chassis. Only the outer locking nut will be outside.
3. When you are ready to mount the Epoxy Pack permanently bring out the wires of the pack on the side next to the PCB. Also, it is helpful to put a blob of silicon glue on each side of the switch toward the ends. This will isolate the pack from chassis and also help in securing tightly.
4. When punching, drilling or otherwise preparing the cover: allow space for the switches to toggle without making contact with the covers. If you wish to make your finished product neat and professional, you might use a piece of patching rubber (Black) to cover the hole. Using a spur type leather punch (generally the largest spur) punch a hole in the center of a small patch. This will fit over the barrel of the switch like a switch boot. Then install covers, not only looks good - but helps lock the nut..

SERVICE HINTS:

If the switch becomes intermittent, remove nuts and washer. You will find a collar made of masking tape on the switch, move this up to form a type of cup around the barrel. Fill the barrel and 'cup' with lighter fluid, toggle the switch back and forth until the problem clears up. Shake out the excess and replace...

NOTE: IF ANY TECHNICAL ASSISTANCE IS NEEDED TO COMPLETE THE MOD OR IF YOU THINK YOU HAVE A FAULTY KIT. - CALL THE NUMBER LISTED ON THE KIT. "CARDKIT" ELECTRONICS WILL BE HAPPY TO ASSIST.....

5K OFFSET

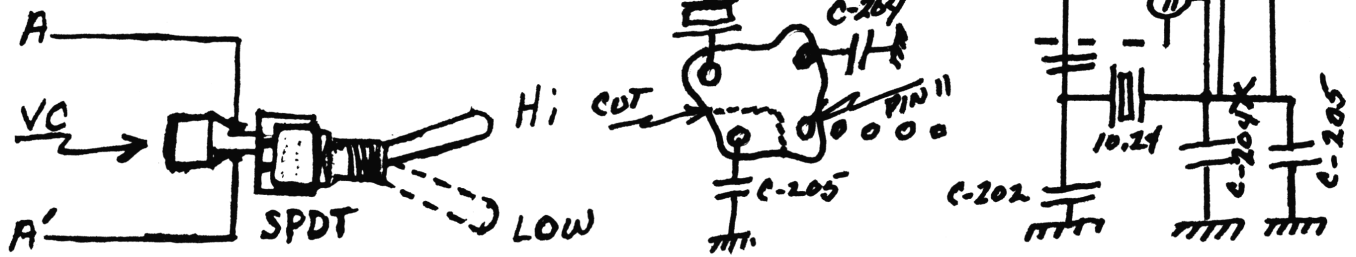

1. Wire up the SPDT switch and the variable capacitor(supplied) as shown above.
2. Remove C-205, Move C-204 to where C-205 was.
3. Cut the printed circuit trace as shown while making sure the 10.24 crystal and pin 11 of the PLL chip are connected.
4. Solder the two wires from the SPDT switch across this cut.
5. With the unit on channel 10, and the SPDT switch in low position, apply power to the unit. Check the TX frequency for a reading of 27.075. If it is too high add a small capacitor across C-205 on the circuit side of the board. If it is too low change C-205 to a smaller value capacitor.

Note: 1pf change in value will shift the frequency approx. 200HZ. If your reading is within 500HZ it is well within tolerance.

6. Switch the SPDT switch to Hi. position and adjust VC for a TX frequency reading of 27.080.

Note: On the Colt 355 we suggest that the existing switch be used for the 5K Offset.

CHANNEL CONVERSION - COBRA 19XS, MIDLAND 103M, COLT 355

1. Remove CF-1 (10.7 ceramic filter). Solder cable #1 in its place. Put the white or yellow wire on the side that is connected to L-103.
2. Remove the jumper connected to pin 20 of the PLL chip. You will find it just under the notched end of the chip.
3. Separate the three wires in cable #2. Connect the orange wire to pin 20 of the PLL chip and the brown wire to the other point where the jumper was removed.
4. Connect the red wire to pin 18 of the PLL chip.
5. With the channel selector on ch. 10, the SPDT switch in low position and the epoxy pack switch in normal, apply power to the unit. Peak the receiver in your normal manner. Mark the setting of L-103.
6. Switch the epoxy pack switch to low position. Inject a low signal level of 26.620 or use a previously modified unit, same settings. Now repeak the receiver using L-103 only. Note the amount and direction of adjustment needed. When you have achieved peak, back the adjustment off by $\frac{1}{2}$ of the signal level increase.
7. Mount the epoxy pack using the mounting hints.

Note: The Midland-103M has a plastic cover.
Drilling is suggested.

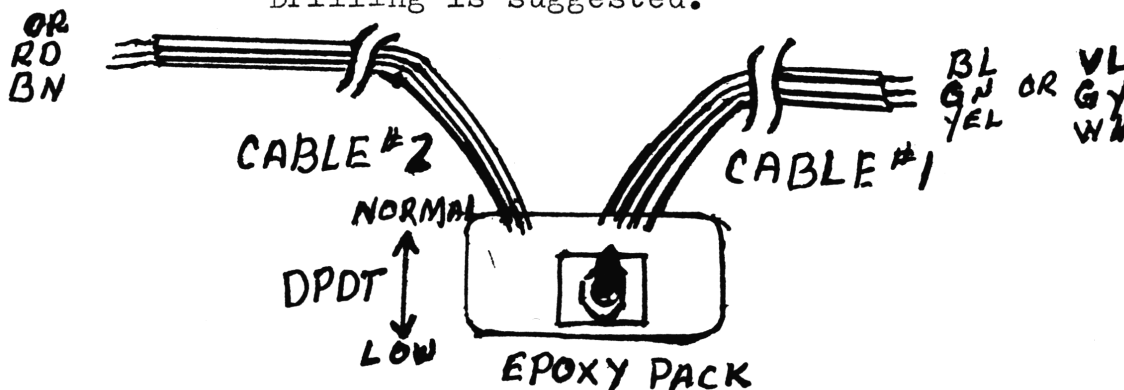

5K OFFSET

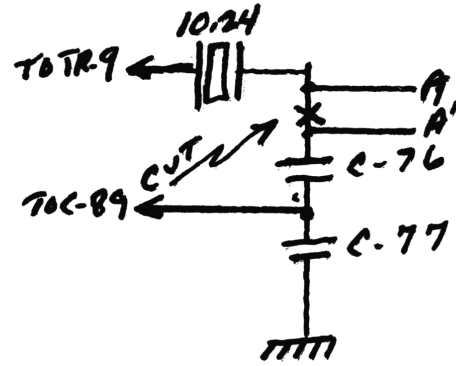
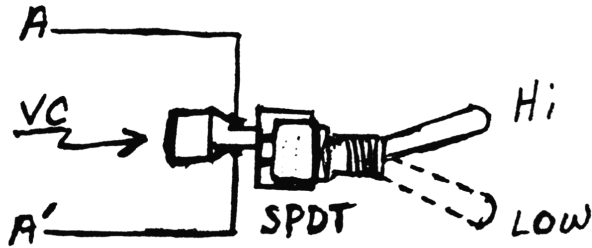

1. Wire up the SPDT switch and the variable capacitor (supplied) as shown above.
2. Cut the printed circuit trace as show, between the 10.24 crystal and C-76.
3. Solder the two wires from the SPDT switch on each side of the cut trace.
4. With the channel selector switch on ch.10 and the SPDT switch in low position, apply power to the unit. Check the TX-frequency for a reading of 27.075. If it is too low change C-76 (47pf) to a smaller value capacitor, about 39pf. Now add small capacitance if needed in parallel to bring the reading back down.
5. Switch the SPDT switch to the Hi position and adjust the VC for a TX-frequency reading of 27.080.

Note: The COBRA 18LTD, President-AX4, & Stalker 3 may be modified in this same manner except you will have to add a 10.695 tank in the place provided and remove the collector load resistor.

CHANNEL CONVERSION - COBRA 20LTD

1. Remove FT-1 (10.7 Ceramic Filter). Solder cable #1 in its place. Put the white or yellow wire on the side that is connected to L-16.
2. Remove R-63.
3. Separate the three wires in cable #2. Connect the orange wire to the point where R-63 was connected to pin 8 of the PLL chip. Connect the brown wire to the other point where R-63 was removed.
4. Connect the red wire to pin 1 of the PLL chip.
5. With the channel selector on ch.10, the SPDT switch in low position and the epoxy pack switch in normal position, apply power to the unit. Peak the receiver in your normal manner. Mark the position of L-16.
6. Switch the epoxy pack switch to low position. Inject a low signal level of 26.620, or use a previously modified unit on the same settings. Repeat the receiver using L-16 only. Note the amount and direction of adjustment required. When you achieve peak back off the adjustment by $\frac{1}{2}$ of the signal level increase.
7. Mount the epoxy pack using the mounting hints.

Note: In most cases the epoxy pack will have to be mounted on the opposite side from the PLL chip.

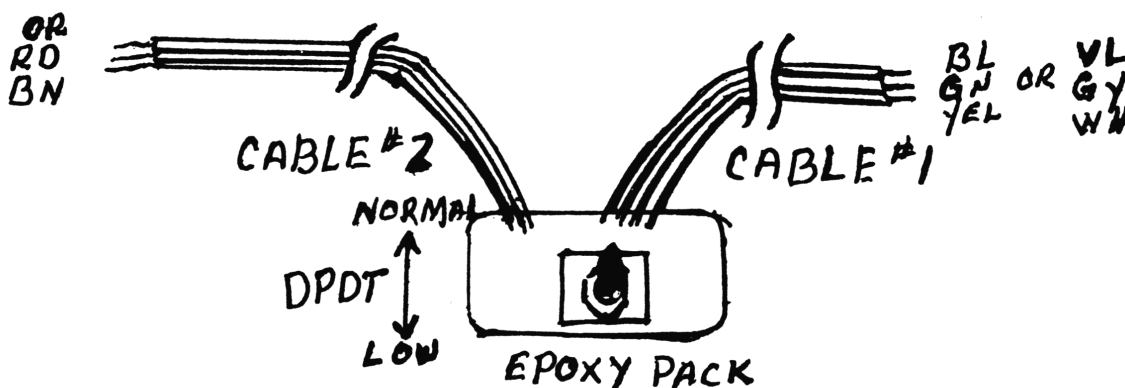

5K OFFSET

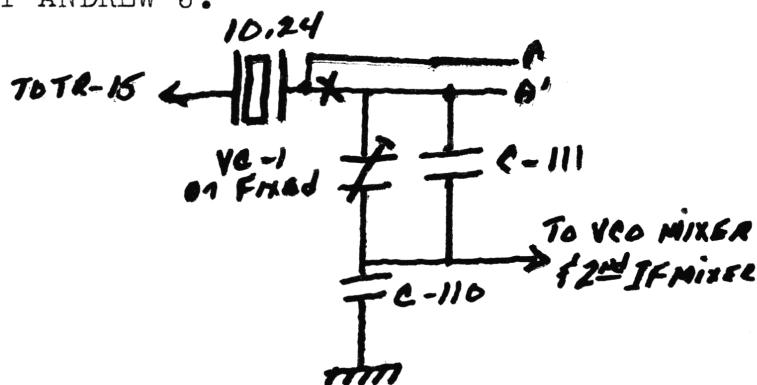
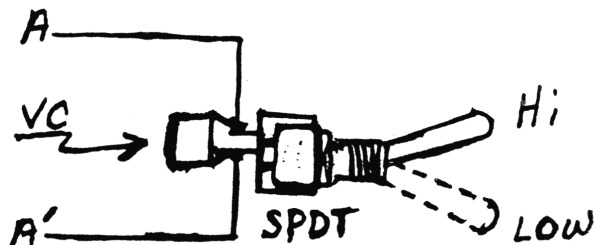

1. Wire up th SPDT switch and the variable capacitor (supplied) as shown above.
2. Cut the printed circuit trace as shown between the 10.24 crystal and C-111 and its parallel capacitance.
3. Solder the two wires from the SPDT switch on each side of the cut as shown.
4. With the channel selector on ch.10 and the SPDT switch on low position, apply power to the unit. Check the TX-frequency for a reading of 27.075. If the reading is too low adjust VC-1 or change the size of the fixed parallel capacitor to bring the reading within tolerance.
5. Switch the SPDT switch to the Hi position and adjust VC for a TX-frequency reading of 27.080.

Note: These units, being the larger units, can easily accommodate both the "A" & "B" Kits, but when using both kits we suggest that IF 5K OFFSET is to be used, use one of the existing switches.

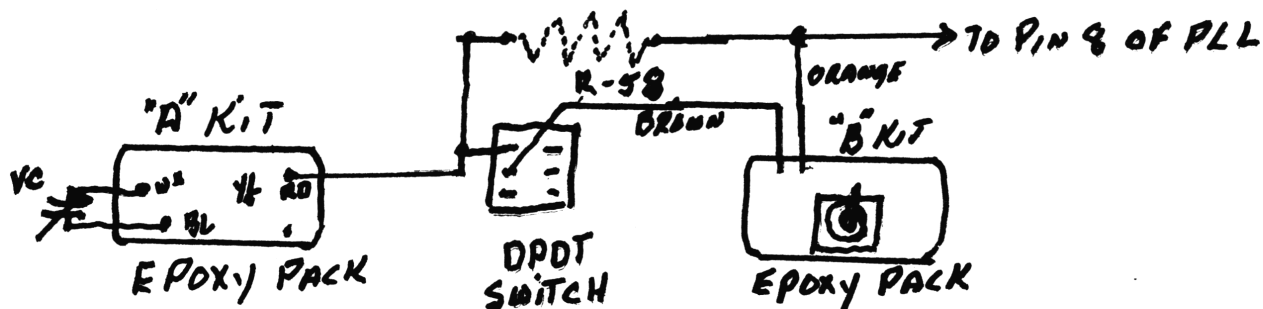

CHANNEL CONVERSION - COBRA 21GTL & LTD, 25GTL & LTD, PRESIDENT AR44
& AX44, AR711 & AX711, PRESIDENT ANDREW J.

1. Remove CF-1 (10.7 ceramic filter). Solder cable #1 in its place. Put the white or yellow wire on the side that is connected to L13.
2. Remove R-58.
3. Separate the three wires in cable #2. Solder the orange wire to the point where R-58 was connected to pin 8 of the PLL chip. Solder the brown wire to the other point R-58 was connected. (If you are using both kits solder the brown wire to the center contact of the DPDT section that is being used for PLL T/R shift.)
4. Solder the red wire to pin 1 of the PLL chip or to the red dot of the "A" Kit epoxy pack.
5. With the channel selector on ch.10, the SPDT switch in low position and the epoxy pack switch in normal position, apply power to the unit. Peak the receiver in your normal manner. Mark the settings of L-3 & L-4.
6. Switch the epoxy pack switch to the low position. Inject a low signal level of 26.620 or use a previously modified unit on the same settings. Repeat the receiver. First use L-3. Bring it to peak and then back it off by 1/3 of the distance of the change in tuning. Now peak again using L-4. Peak it and then back it off by 1/3 of the change in tuning.

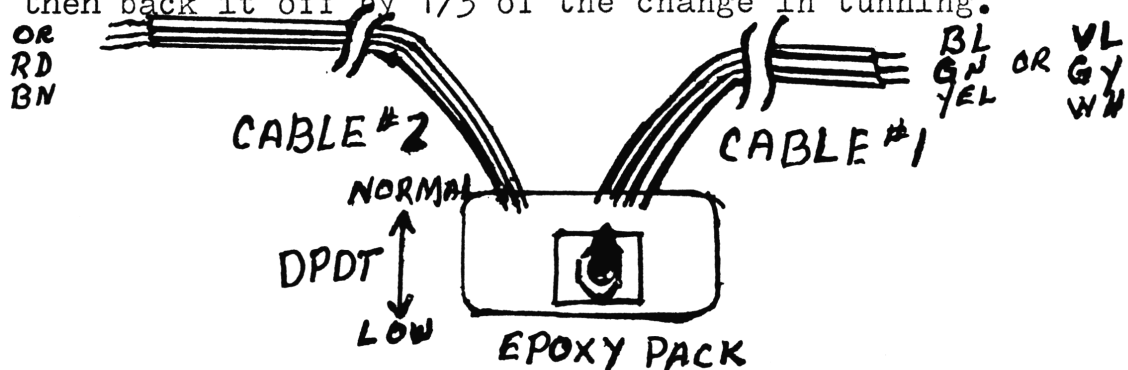

7. Mount the epoxy pack using the mounting hints.

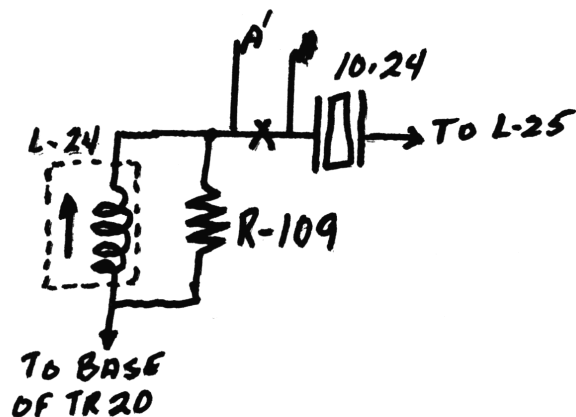
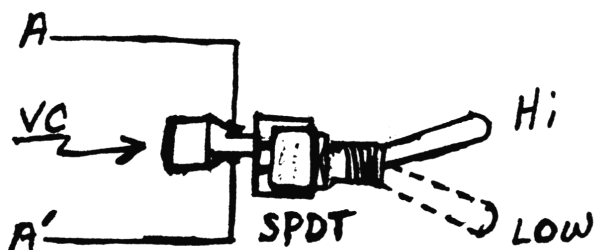
5 K OFFSET

1. Wire up the SPDT switch and the variable capacitor (supplied) as show above.
2. Cut the printed circuit trace as shown between the 10.24 crystal and R-109 paralleled by L-24.
3. Solder the two wires from the SPDT switch on each side of the cut as shown.
4. With the channel selector on ch. 10 and the SPDT switch in low position, apply power to the unit. Check the TX-frequency for a reading of 27.075. If needed adjust L-24 to obtain this reading.
5. Switch the SPDT switch to the Hi position and adjust the VC for a TX-frequency reading of 27.080.

NOTE: Although this is a large unit and can easily accommodate both the "A" & "B" Kits. you can not acheive evenpower tracking over the entire range from 26.510 to 27.860 and it is not for the same reason as other kits (like of VCO tracking). It is due to the narrow band-pass of L-20 and L-21.

CHANNEL CONVERSION - COBRA 29 GTL & LTD

1. Remove FL-1 (10.7 ceramic filter). Solder cable #1 in its place. Put the white or yellow wire on the side connected to L-5
2. Cut the printed circuit trace between the anode of D-15 and pin 9 of PLL chip.
3. Separate the three wires of cable #2. Solder the orange wire to pin 9 of the PLL chip and the brown wire to the anode side of D-15.
4. Solder the red wire to pin 11 of the PLL chip.
5. With the channel selector on ch. 10, the SPDT switch in low position and the epoxy pack switch in normal position, apply power to the unit. Peak the receiver in your normal manner. Mark the settings of L-5 & L-6.
6. Switch the epoxy pack switch to low position. Inject a low signal level of 26.620, or use a previously modified unit on the same settings. Repeak the unit. First bring L-5 to peak and then back it off by 1/3 of the increase in signal strength. Now bring L-6 to peak and then back it off by 1/3 of the gain in signal strength.
7. Mount the epoxy pack using the mounting hints.

NOTE: If you have a unit with the "ZAPPER" 9000 installed in it. The "B" kit is compatible, but do not use the 5K OFFSET.

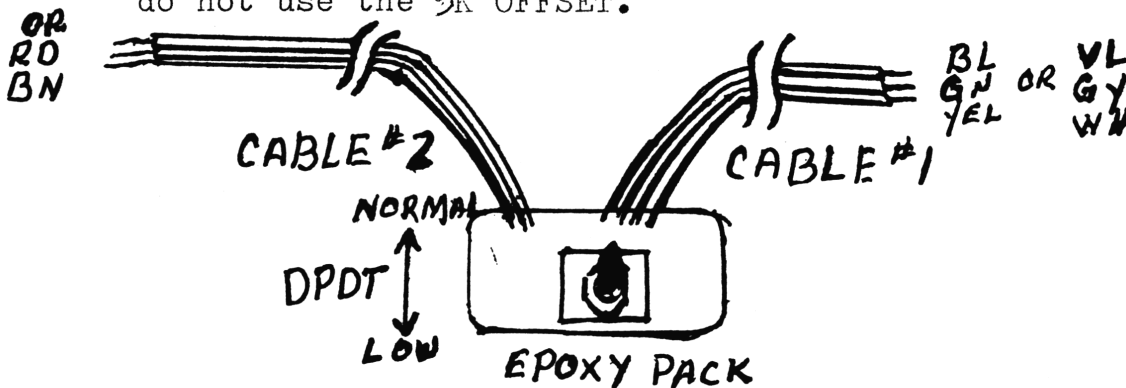

COBRA -19X, COLT -210, GE-3-5805B, MAXCOM-4A
 MIDLAND 100M, 102M, 150M, 151M, 800M, 2001, 3001,4001

5K OFFSET (not recommended for the Midland 800M)

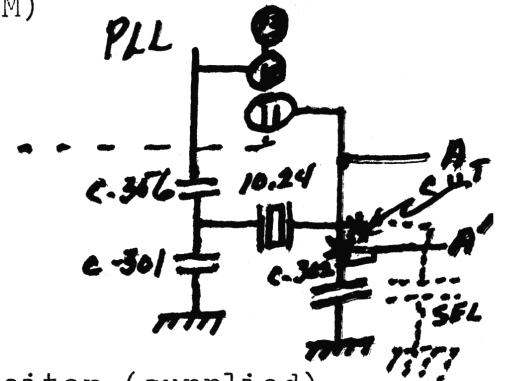
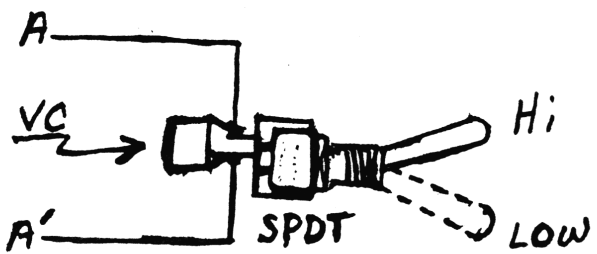

1. Wire the SPDT switch and the variable capacitor (supplied) as shown above.
2. Cut the printed circuit trace as shown between the 10.24 crystal and C-302 withits parallel capacitor if present.
3. Solder the two wires from the SPDT switch on each side of the cut as shown above.
4. With the channel selector switch on ch.10 and the SPDT switch in low position apply power to the unit. Check the TX-frequency for a reading of 27.075. If the reading is too low decrease the value of C-302 or if there is a selected parallel capacitor, change its value. If the reading is too high then increase the value of C-302 or its parallel capacitor.
5. Switch the SPDT switch to the Hi position and adjust VC for a TX-frequency reading of 27.080.

NOTE: The Colt-355 is a very small unit. Space to mount even the epoxy pack is difficult, so we suggest that IF 5K OFFSET is to be used that you use the existing switch.

ALSO

Most of these units are large enough to accommodate both the "A" & "B" kits. Read modification for COBRA-21&25GTL & LTD. Adapt in the same manner except there would be a cut where the R-58 was.

CHANNEL CONVERSION - Cobra 19X, Colt 210, GE 3-5805B, Maxcom 4A, Midland 100M,102M,150M,151M,800M,2001,3001,4001

1. Remove CF-1 (10.7 Ceramic filter). Solder cable #1 in its place. Put the white or yellow wire to the side that is connected to L-103.
2. Cut the printed circuit trace running between the Anode of D-206 and pin 20 of the PLL chip. (On most of these units this run is right on the front edge of the mother board and can easily be nicked.)
3. Separate the three wires of cable #2. Solder the orange wire to pin 20 of the PLL chip. Solder the brown wire to the side of the cut connected to the anode of D-206.
4. Solder the red wire to pin 18 of the PLL chip.
5. With the channel selector on ch. 10, the SPDT switch on low position and the epoxy pack switch in normal position, apply power to the unit. Peak the receiver in your normal manner. Mark the settings of L-103 & L-104.
6. Switch the epoxy pack switch to the low position. Inject a low signal level of 26.620 or use a previously modified unit on the same settings. Repeat the receiver. First peak using L-103. Bring it to peak then back it off by 1/3 of the increased signal strength. Now peak using L-104, bring it to peak and then back it off by 1/3 of the increase in signal strength.

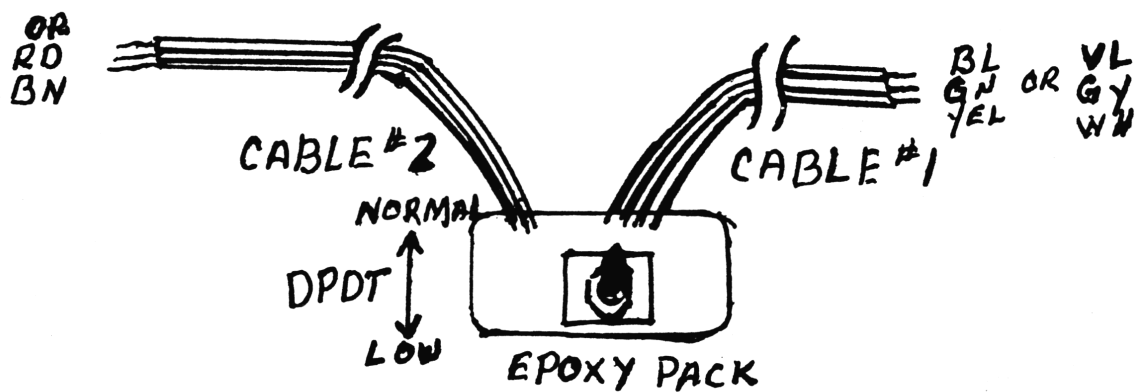

7. Mount the epoxy pack using the mounting hints.

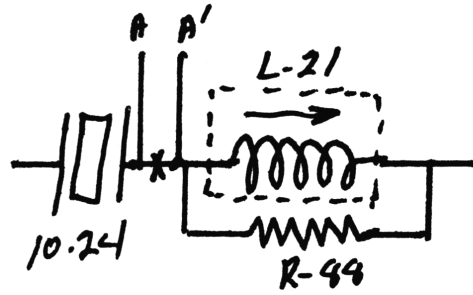
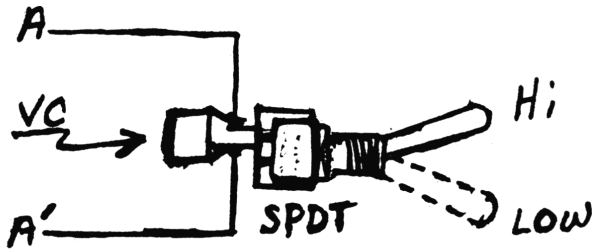
5K OFFSET

1. Wire up the SPDT switch and the variable capacitor (supplied) as shown above.
2. Cut the printed circuit trace as shown between the 10.24 crystal and R-88 with its parallel tank L-21.
3. Solder the two wires from the SPDT switch on each side of the cut as shown.
4. With the channel selector on ch.10 and the SPDT switch in low position, apply power to the unit. Check the TX-frequency for a reading of 27.075. If needed adjust L-21 to obtain this reading.
5. Switch the SPDT switch to the Hi position and adjust the VC for a TX-frequency reading of 27.080.

NOTE: This being a large unit, can easily accommodate both the "A" & "B" Kits. Refer to material covering the Cobra 21 & 25 GTL & LTD. It will be the same except substitute R-92 in place of R-58

CHANNEL CONVERSION - Midland 200M

1. Remove FL-1 (10.7 ceramic filter). Solder cable #1 in its place. Put the white or yellow wire on the side connected to L-3
2. Remove R-92.
3. Separate the three wires in cable #2. Solder the orange wire to the point where R-92 was connected to pin 8 of the PLL chip. Solder the brown wire to the other point R-92 was connected.
4. Solder the red wire to pin 1 of the PLL chip.
5. With the channel selector on ch.10, the SPDT switch in low position and the epoxy pack switch in normal position, apply power to the unit. Peak the unit in your normal manner. Mark the settings of L-3 & L-4
6. Switch the epoxy pack switch to the low position. Inject a low signal level of 26.620 or use a previously modified unit on the same settings. Repeat the receiver using first L-3. Bring the signal level to peak and then back it off by 1/3 of the achieved increase in signal strength. Now using L-4 bring the receiver to peak. Again back it off by 1/3 of the gain in signal strength.
7. Mount the epoxy pack using the mounting hints.

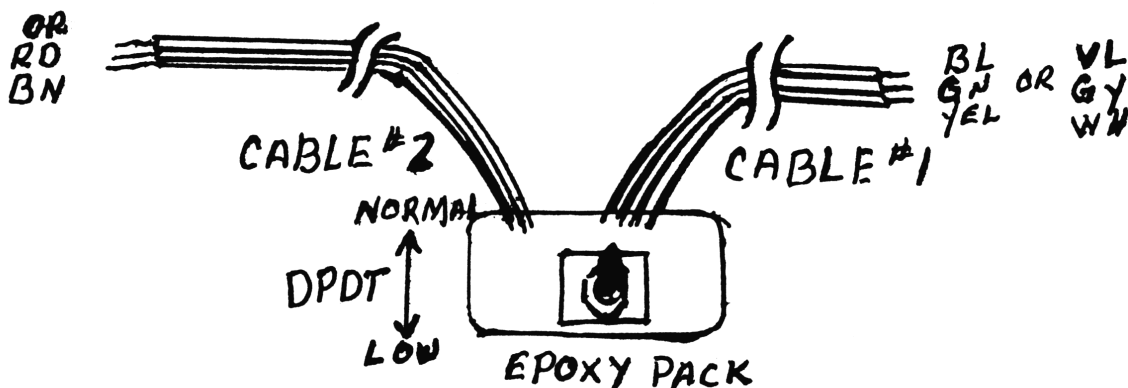

5 K OFFSET

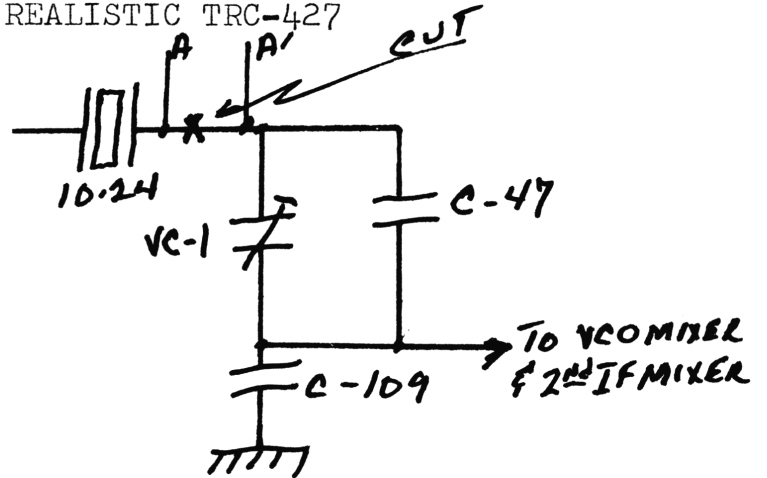
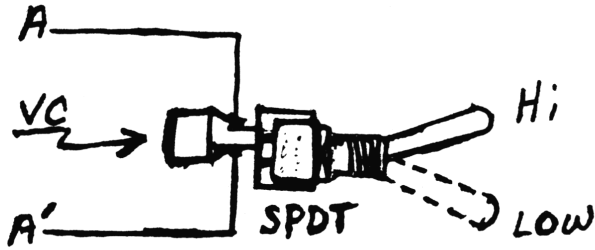

1. Wire up the SPDT switch and the variable capacitor (supplied) as shown above.
2. Cut the printed circuit trace as shown between the 10.24 crystal and C-47 with its parallel VC-1.
3. Solder the two wires from the SPDT switch on each side of this cut as shown.
4. With the channel selector on ch.10 and the SPDT switch on low position apply power to the unit. Check the TX-frequency for a reading of 27.075. If needed adjust VC-1 to obtain this reading.

NOTE: These are larger units and can easily accommodate both the "A" & "B" kits. Refer to the data on Cobra 21 & 25 GTL & LTD. The removed resistor would be R-71 instead of R-58.

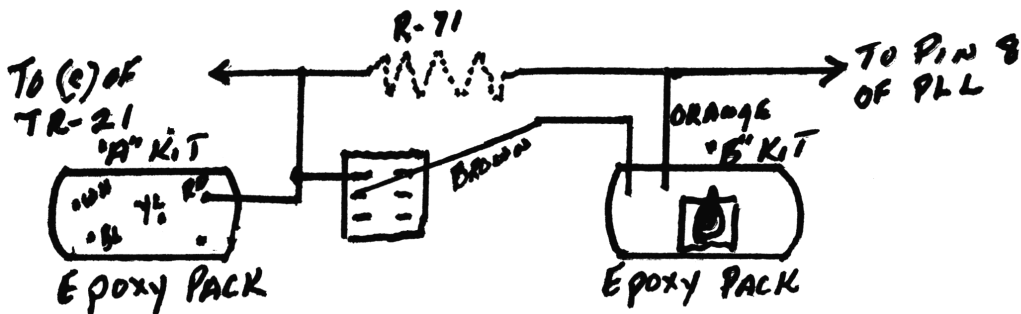

CHANNEL CONVERSION-- Midland 77-824B & Realistic TRC-427

1. Remove CF-1 (10.7 ceramic filter). Solder cable #1 in its place. Put the white or yellow wire on the side that is connected to L-3.
2. Remove R-71.
3. Separate the three wires of cable #2. Solder the orange wire to the point where R-71 was connected to pin 8 of the PLL chip. Solder the Brown wire to the other point where R-71 was connected.
4. Solder the red wire to pin 1 of the PLL chip.
5. With the channel selector on ch. 10, the SPDT switch in low position and the epoxy pack switch in normal position, apply power to the unit. Peak the receiver in your normal manner. Mark the settings of L-3 & L-4.
6. Switch the epoxy pack switch to its low position. Inject a low signal level of 26.620, or use another unit that was previously modified on the same settings. Repeat the receiver. First use L-3 and bring the receiver to peak, then back it off by 1/3 of the increase in signal strength gain. Next, bring the receiver to peak again using L-4, then back it off by 1/3 of the increase in signal strength.
7. Mount the epoxy pack using the mounting hints.

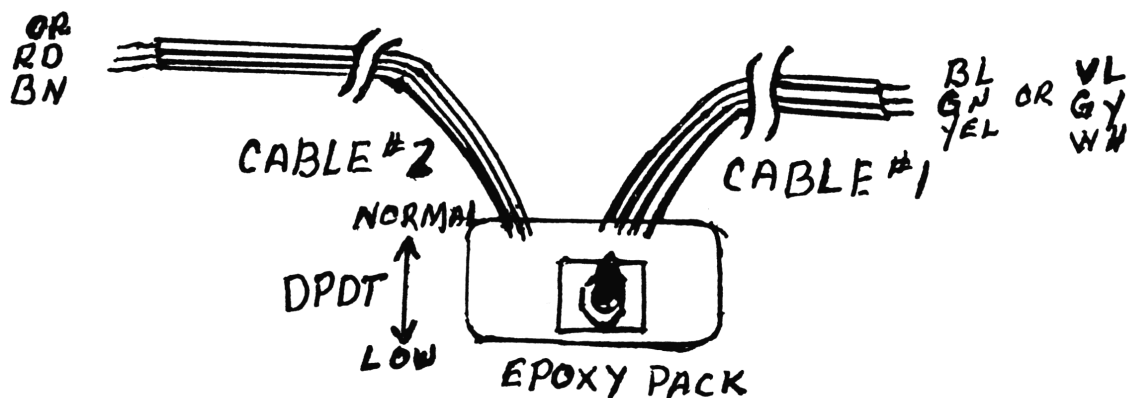

5 K OFFSET

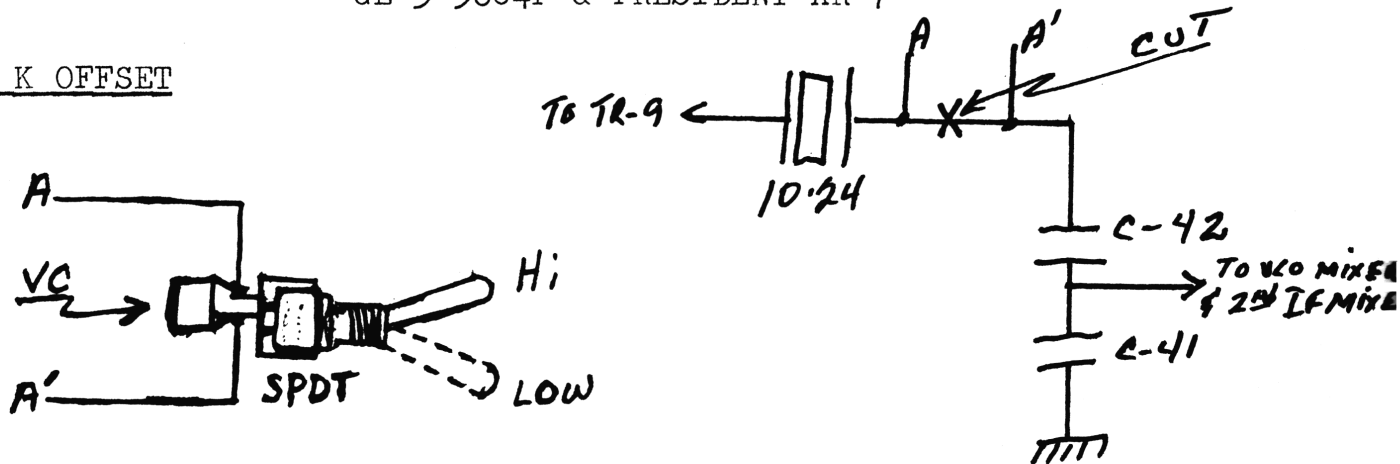

1. Wire the SPDT switch and the variable capacitor (supplied) as shown above.
2. Cut the printed circuit trace as shown between the 10.24 crystal and C-42.
3. Solder the two wires from the SPDT switch on each side of this cut as shown.
4. With the channel selector on ch. 10 and the SPDT switch in low position apply power to the unit. Check the TX-frequency for a reading of 27.075. If the reading is too low replace C-42 with a smaller value capacitor (approx. 47pf.), then trim on frequency by adding very small value capacitors in parallel with it. (printed circuit side.)
5. Switch the SPDT switch to Hi position and adjust the VC for a TX-frequency reading of 27.080.

NOTE: These units are mid-size units but it might be difficult to mount the epoxy pack on the same side of the unit as the PLL chip is located. You will find sufficient space on the opposite side.

CHANNEL CONVERSION - GE 3-5804F & President AR-7

1. Remove FL-1 (ceramic filter). Solder cable #1 in its place. Put the white or yellow wire on the side the is connected to L-4.
2. Remove R-47.
3. Separate the three wires of cable #2. Solder the orange wire to the point where R-47 was connected to pin 8 of the PLL chip. Solder the brown wire to the other point where R-47 was connected
4. Solder the red wire to pin 1 of the PLL chip.
5. With the channel selector on ch.10, the SPDT switch in low position and the epoxy pack switch in normal position, apply power to the unit. Peak the receiver in your normal manner. Mark the settings of L-4 & L-6.
6. Switch the epoxy pack switch to the low position. Inject a low signal level of 26.620, or use a previously modified unit on the same settings. Repeak the receiver. First bring it to peak by adjusting L-4, then back it off by 1/3 of the increase in signal that the adjustment made. Next bring the receive to peak again using L-6. Again back it off by 1/3 of the gained signal strength.
7. Mount the epoxy pack using the mounting hints.

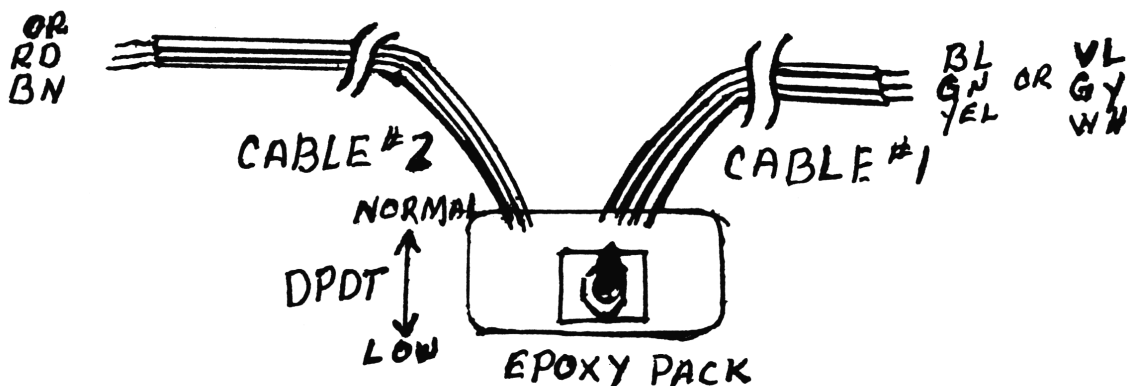

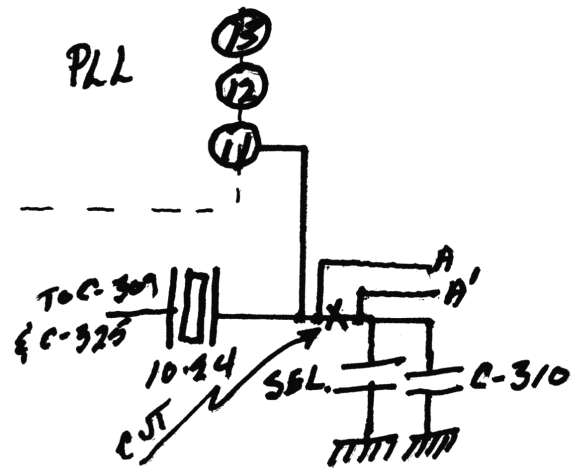
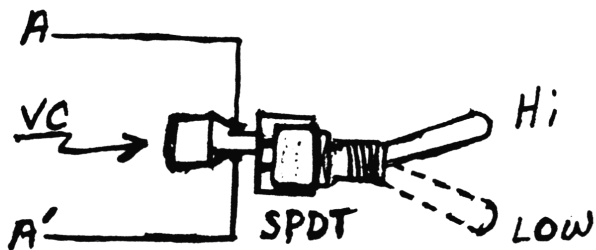
5K OFFSET

NOTE: This unit like the Colt-355 is an extra small unit and it is hard to even find space for the epoxy pack. We strongly suggest using the existing switch IF 5K Offset is desired.

1. If you do select to incorporate the 5K Offset, cut the printed circuit trace between the 10.24 crystal and C-310 with its selected trimmer. as shown above.
2. Solder the two wires from the installed VC to each side of the cut trace.
3. With the channel selector on ch.10 and the switch in the position that would short across the VC, apply power to the unit. Check the TX-frequency for a reading of 27.075. If the reading is too low remove or replace the sel. parallel capacitor . A change of 1pf. will shift the frequency \pm 100 to 200 Hz.
4. Switch the existing switch to its other position and adjust the VC for a reading of 27.080.

CHANNEL CONVERSION - K-40's K-401

1. Remove CF-1 (10.7 ceramic filter). Solder cable #1 in its place. Put the white or yellow wire on the side that is connected to L-203.
2. Cut the printed circuit trace between the anode of D-401 and pin 20 of the PLL chip.
3. Separate the three wires of Cable #2. Solder the orange wire to pin 20 of the PLL chip. Solder the brown wire to the side of the cut trace connected to the anode of D-401.
4. Solder the red wire to pin 18 of the PLL chip.
5. With channel selector on ch. 10, the existing switch on shorted position and the epoxy pack switch on normal position, apply power to the unit. Peak the unit in your normal manner. Mark the settings of L-203 & L-204.
6. Switch the epoxy pack switch to the low position. Inject a low signal level of 26.620 or use another unit previously modified on the same settings. Repeat the receiver using L-203 and L-204 only. First peak using L-203 then back it off by 1/3 of the achieved gain in signal strength. Then peak again using L-204. Back it off by 1/3 of the increase in signal strength.
7. Mount the epoxy pack using the mounting hints.

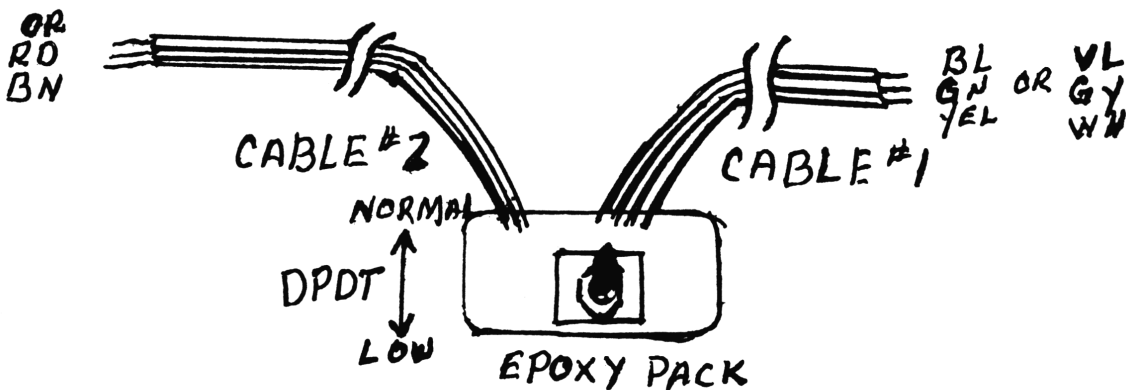

5K OFFSET

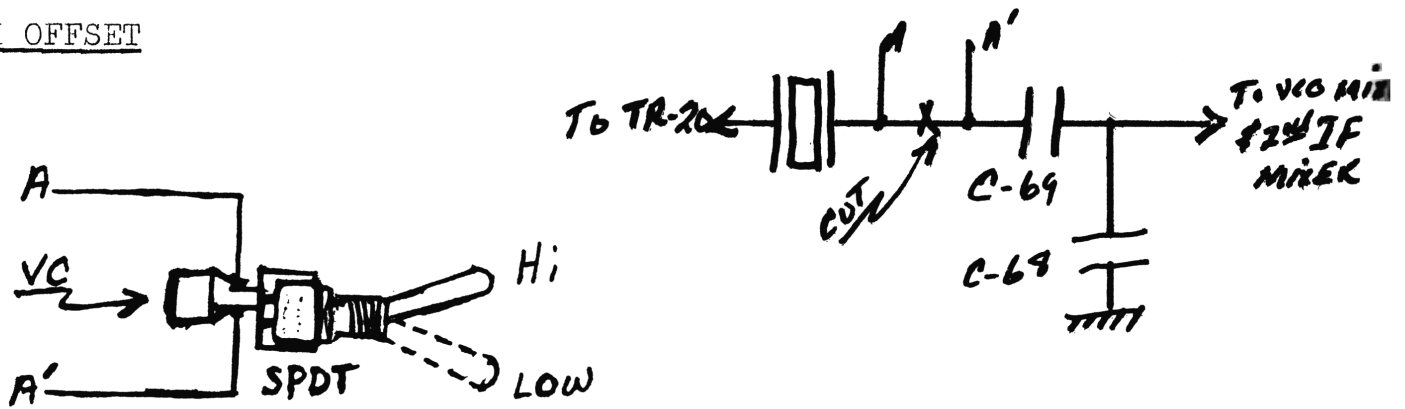

NOTE: Since this is a remote unit, the prime concern is that the unit will be located properly in order the switch or switched can be reached for operation.

1. Wire up the SPDT switch and the variable capacitor (supplied) as shown above.
2. Cut the printed circuit trace between the 10.24 crystal and C-69 as shown.
3. Solder the two wires from the SPDT switch to each side of the trace cut as shown.
4. With the channel selector on ch.10 and the SPDT switch in low position, apply power to the unit. Check the TX-frequency for a reading of 27.075. If the frequency is too high, add a small value trimmer in parallel with C-69. If the reading is too low replace C-69 with smaller value capacitor (approx 39pf) and if need be add parallel capacitors across it to bring the transmitter on frequency.
5. Switch the SPDT switch to the Hi position and adjust the VC for a TX-frequency reading of 27.080.

CHANNEL CONVERSION - PRESIDENT AX-11

1. Remove FL-1 (10.7 ceramic filter). Solder cable #1 in its place. Put the white or yellow wire on the side connected to L-3.
2. Cut the printed circuit trace between the anode of D-21 and pin 20 of the PLL chip.
3. Separate the three wires of cable #2. Solder the orange wire to pin 20 of the PLL chip. Solder the brown wire to the side of the trace cut connected to the anode of D-21.
4. Solder the red wire to pin 18 of the PLL chip.
5. With the channel selector on ch.10, the SPDT switch in low position and the epoxy pack switch in normal position, apply power to the unit. Peak the unit in your normal manner. Mark the position of L-3 & L-4.
6. Switch the epoxy pack switch to the low position. Inject a low signal level of 26.620 or use a previously modified unit on these same settings. Repeat the receiver using L-3 & L-4 only. First bring the receiver to peak with L-3 then back it off by 1/3 of the increase in signal strength gained. Next, bring the receiver to peak using L-4 and again back it off by 1/3 of the increase in signal strength gained.

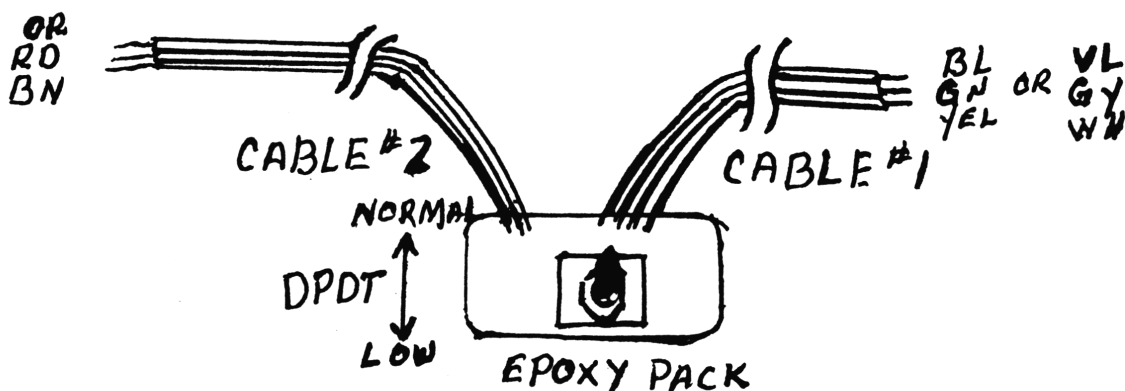

7. Mount the epoxy pack using the mounting hints.

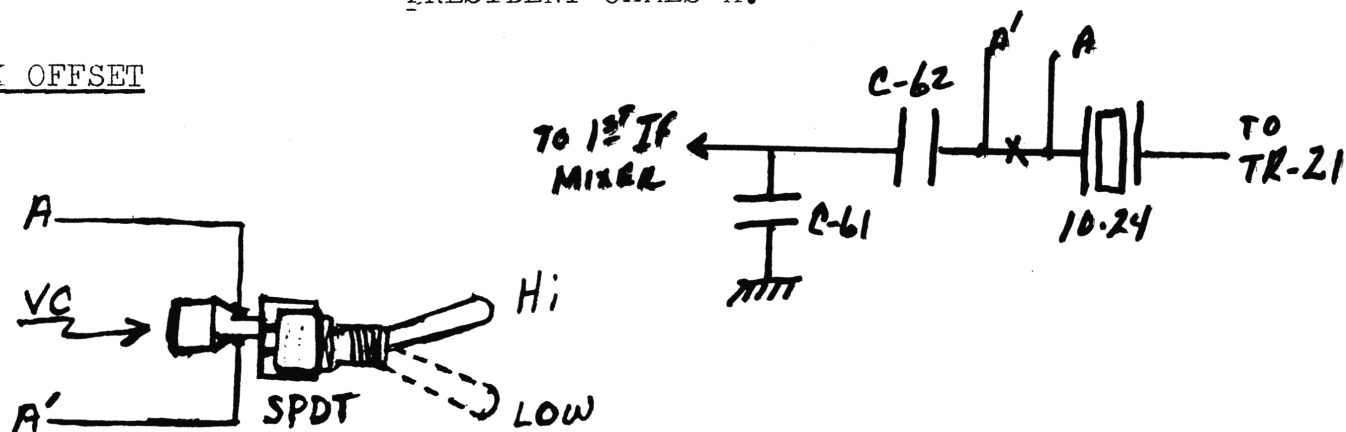
5K OFFSET

1. Wire up the SPDT switch and the variable capacitor (supplied) as shown above.
2. Cut the printed circuit trace as shown between C-62 and the 10.24 crystal.
3. Solder the two wires from the SPDT switch across this cut as shown.
4. With the channel selector on ch.10 and the SPDT switch in low position apply power to the unit. Check the TX-frequency for a reading of 27.075. If the reading is too low change C-61 to a smaller value capacitor (approx. 39pf.) then if needed, add or trim it on frequency by paralleling it with a small capacitor on the printed side of the board.
5. Switch the SPDT switch to the Hi position and adjust the VC for a TX-frequency of 27.080.

NOTE: Since this is a remote unit, the prime concern is that the unit will be located properly in order the switch or switches can be reached for operation.

CHANNEL CONVERSION - PRESIDENT JAMES K

1. Remove CF-1 (10.7 ceramic filter). Solder cable#1 in its place. Put the white or yellow wire on the side connected to L-3
2. Cut the printed circuit trace between the anode side of D-17 and pin 9 of the PLL chip.
3. Separate the three wires of cable #2. Solder the orange wire to pin 9 of the PLL chip. Solder the brown wire on the side of the cut connecting to the anode of D-17.
4. Solder the red wire to pin 11 of the PLL chip.
5. With the channel selector on ch.10, the SPDT switch in low position and the epoxy pack switch in normal position, apply power to the unit. Peak the unit in your normal manner. Mark the settings of L-3 & L-4.
6. Switch the epoxy pack switch to low position. Inject a low signal level of 26.620 or use a previously modified unit on these same settings. Repeat the receiver using L-3 & L-4 only. First bring the receiver to peak using L-3 then back it off by 1/3 of the achieved increase in signal strength. Next, bring the receiver to peak again using L-4 then back it off by 1/3 of the signal strength increase.
7. Mount the epoxy pack using the mounting hints.

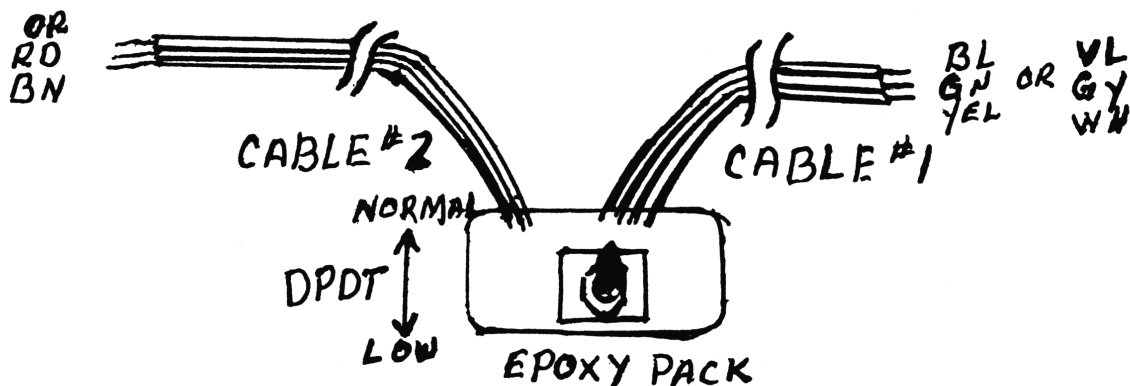

5K OFFSET

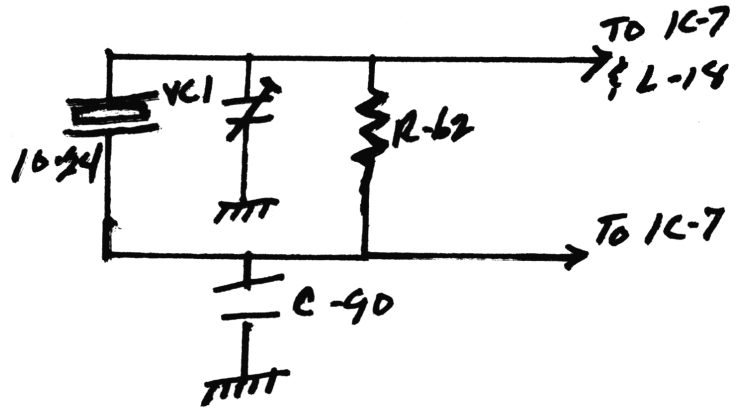
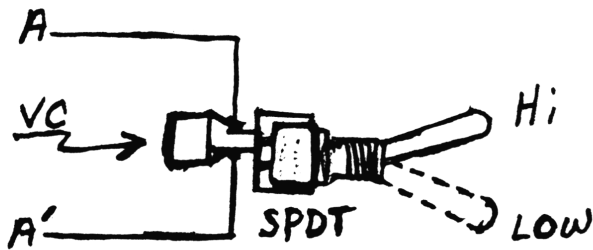

1. Wire the SPDT switch and the variable capacitor (supplied) as shown above.
2. Lift the leg of C-90 that is connected to the 10.24 crystal
3. Solder the two wires from the SPDT switch on each side of this break. One to the point the leg of C-90 was lifted from and the other to the lifted leg of C-90.
4. With the channel selector on ch.10 and the SPDT switch in low position, apply power to the unit. Check the TX-frequency for a reading of 27.075. If needed adjust VC-1 to obtain this reading.
5. Switch the SPDT switch to the Hi position and adjust the VC for a TX-frequency of 27.080.

NOTE: This unit, being one of the larger units can easily accommodate both the "A" & "B" Kits, but when using both kits we suggest that IF 5K OFFSET is to be used, use one of the existing switches.

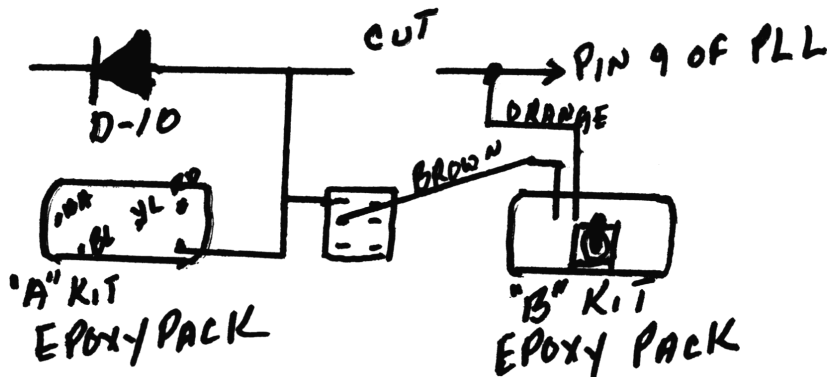

CHANNEL CONVERSION - PRESIDENT "OLD HICKORY"

1. Remove XF-1 (10,7 ceramic filter). Solder cable #1 in its place. Put the white or yellow wire on the side that is connected to L-3.
2. Cut the printed circuit trace between the anode of D-10 and pin 9 of the PLL chip.
3. Separate the three wires in cable #2. Solder the orange wire to pin 9 of the PLL chip. Solder the brown wire to the side of the cut that connects to the anode of D-10.
4. Solder the red wire to pin 11 of the PLL chip.
5. With the channel selector on ch.10, the SPDT switch in low position and the epoxy pack switch in normal position, apply power to the unit. Peak the unit in your normal manner. Mark the setting of L-3.
6. Switch the epoxy pack switch to low position. Inject a low signal level of 26.620 or use a previously modified unit on the same settings. Repeat the receiver using L-3 only. Bring the receiver to peak and then back it off by $\frac{1}{2}$ of the gain in receiver signal strength.
7. Mount the epoxy pack using the mounting hints.

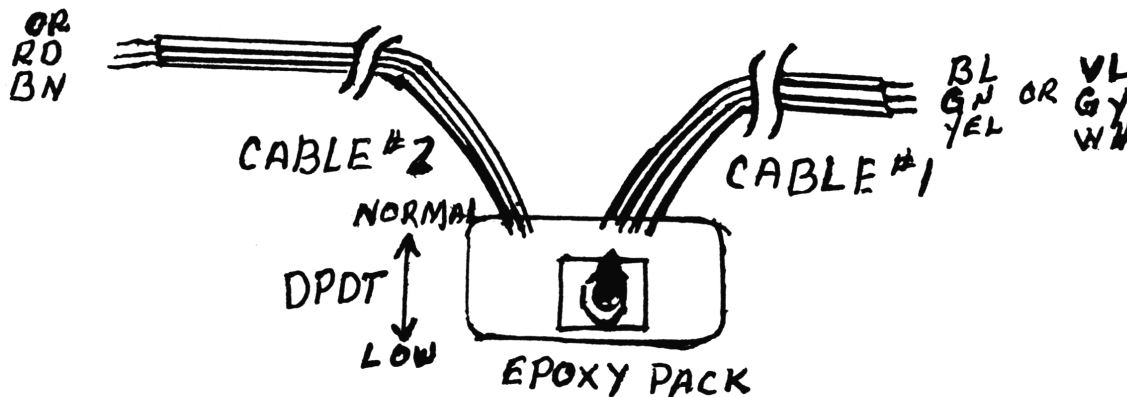

5 K OFFSET

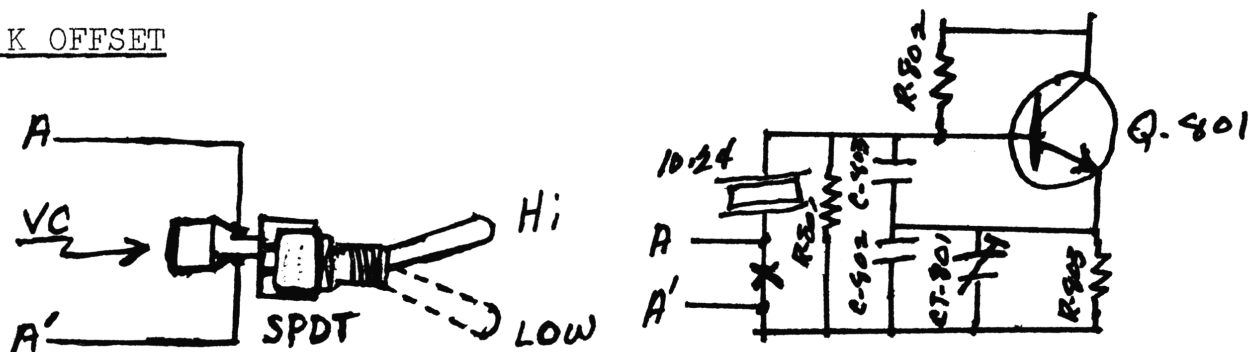

1. Wire the SPDT switch and the variable capacitor (supplied) as shown above.
2. Cut the printed circuit trace on the ground side of the 10.24 crystal as shown.
3. Solder the two wires from the SPDT switch on each side of this cut as shown.
4. With the channel selector switch on ch.10 and the SPDT switch on low position, apply power to the unit. Check the TX-frequency for a reading of 27.075. If needed adjust CT-801 to obtain this frequency.
5. Switch the SPDT switch to the Hi position and adjust the VC for a TX-frequency reading of 27.080.

NOTE: This unit, being one of the larger units, can easily accommodate both the "A" & "B" Kits we suggest that IF 5K OFFSET is to be used, use one of the existing switches. For drawings and notes see Cobra 21 & 25 GTL & LTD.

CHANNEL CONVERSION - REALISTIC TRC-425

1. Remove F-301 (10.7 Ceramic filter). Solder cable #1 in its place. Put the white or yellow wire on the side connected to T-301.
2. Cut the printed circuit trace between the anode of D-802 and pin 8 of the PLL chip.
3. Separate the three wires of cable #2. Solder the orange wire to pin 8 of the PLL chip. Solder the brown wire to the other side of the cut connected to the anode of D-802.
4. Solder the red wire to pin 1 of the PLL chip.
5. With the channel selector on ch. 10, the SPDT switch in low position and the epoxy pack switch in normal position, apply power to the unit. Peak the unit in your normal manner. Mark the setting of T-301.
6. Switch the epoxy pack switch to low position. Inject a low signal level of 26.620, or use a previously modified unit on these same settings. Repeat the receiver using T-301 only. Bring the receiver to peak then back off the adjustment by 1/2 of the gain in signal strength achieved by the adjustment.
7. Mount the epoxy pack using the mounting hints.

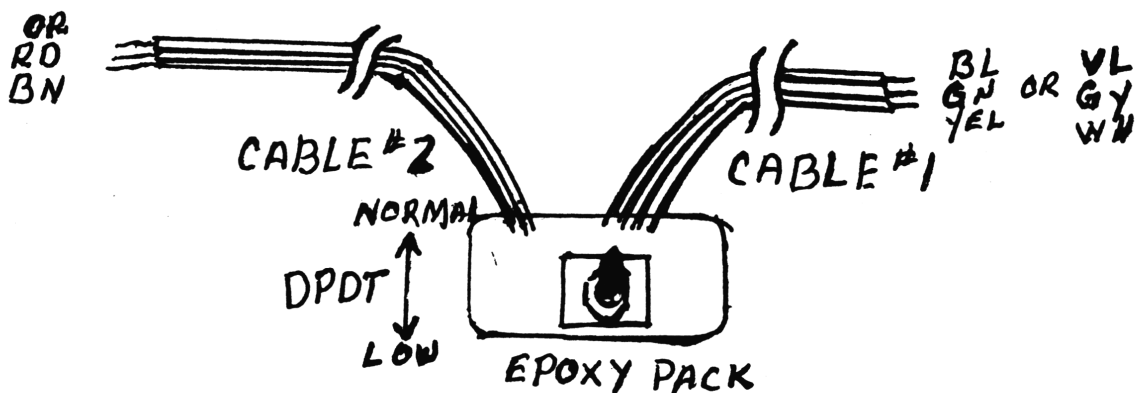

REALISTIC TRC-426

5K OFFSET

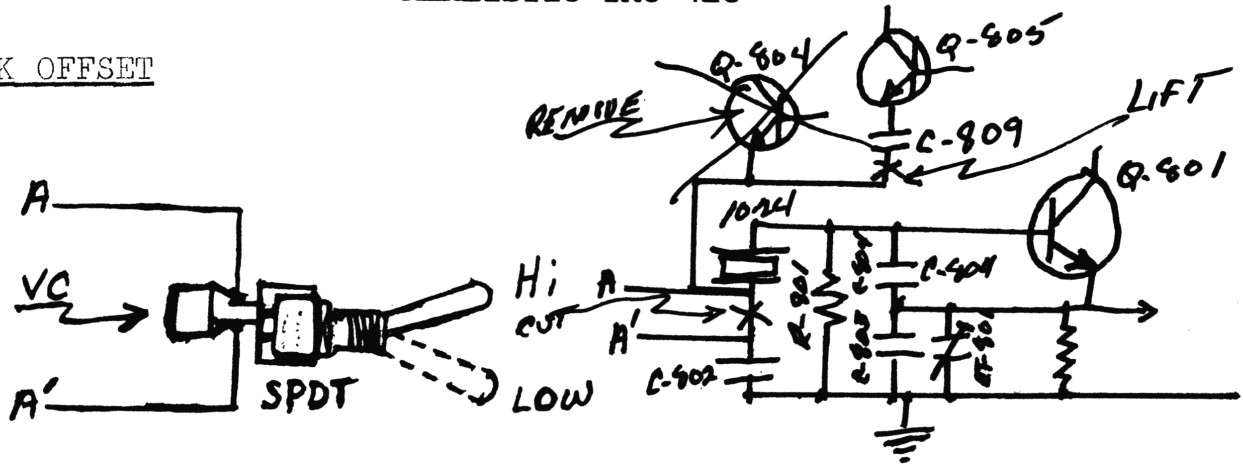

NOTE: This is a phone type unit. The best place to mount the switches would be on the back chassis wall. Drill the holes at the point where the two clam shell covers meet.

1. Wire up the SPDT switch and the variable capacitor (supplied) as shown above.
2. Cut the printed circuit trace between C-802 and the 10.24 crystal as shown above. Remove Q-804. Lift the leg of C-809 that is connected to this same point. (Note this disables delta tune).
3. Solder the two wires from the SPDT switch on each side of the cut made as shown above.
4. With the channel selector on ch.10 and the SPDT switch in low position, apply power to the unit. Check the TX-frequency for a reading of 27.075. If needed adjust CT-801 to obtain this frequency.
5. Switch the SPDT switch to Hi position and adjust the VC for a TX-frequency reading of 27.080.

CHANNEL CONVERSION - REALISTIC TRC-426

1. Remove F-301 (10.7 ceramic filter). Solder cable #1 in its place. Put the white or yellow wire on the side connected to T-301.
2. Remove R-808.
3. Separate the three wires of cable #2. Solder the orange wire to pin 8 of the PLL chip. Solder the brown wire to the other point where R-808 was connected.
4. Solder the red wire to pin 1 of the PLL chip.
5. With the channel selector on ch.10, the SPDT switch on low position and the epoxy pack switch in normal position, apply power to the unit. Peak the unit in your normal manner. Mark the position of T-301.
6. Switch the epoxy pack switch to the low position. Inject a low signal level of 26.620 or use a previously modified unit. Repeak the receiver using T-301 only. Bring the receiver to peak then back it off by 1/2 of the achieved increase in signal strength.
7. Mount the epoxy pack using the note on the previous page and the mounting hints.

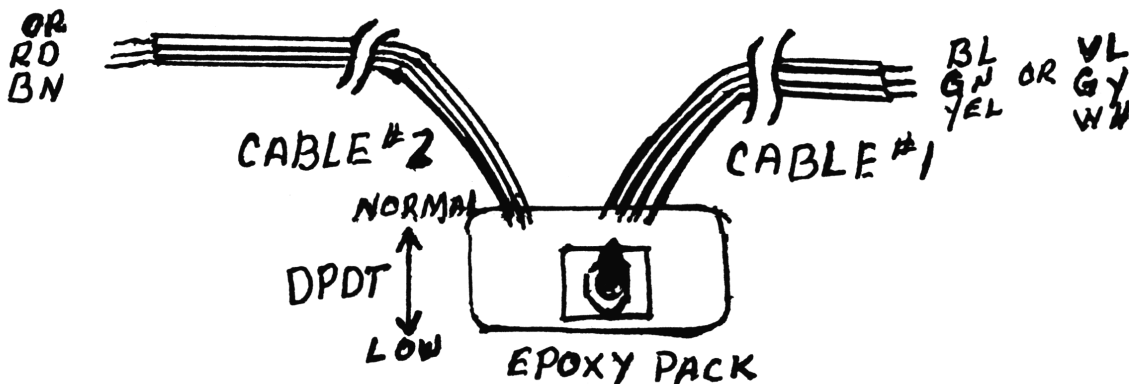

SPECIFIC TUNE-UPS

REALISTIC TRC-211, 5W/6 Ch. Walkie Talkie - NEW for '84.

RF/Battery meter; Hi/Low Power; External Jacks: Mike, Speaker, Power, Charger and Antenna.

TX Adjustments: Power switch HIGH; T6, L3, L6, L7, VR5
 AMC - High Power: VR3
 Low Power: VR2
 Modulation Limiter Disable: R49 (1K)

RX Adjustments: T1, T2, T3, T4
 SQ RNG - VR1

FINAL is a 10 Watt/3 Amp., push it!

REALISTIC TRC-212, 5W/40 Ch. Walkie Talkie (TC9109BP-PLL) - NEW for '84

LCD Ch/RF/Battery indicator; Hi/Low Power; External Jacks: Mike, Speaker, Power, Charger, and Antenna.

TX Adjustments: Power switch HIGH; T5, T6, T7, L8, L11, L12, VR4
 AMC - High Power: VR3
 Low Power: VR2
 Modulation Limiter Disable: C76 (1Mfd/50V elect.)

RX Adjustments: T2, T3, T1, L1, T4
 SQ RNG - VR1

FINAL is a 10 Watt/3 Amp., push it!

(Note: This unit will take a SKIP mod., but am working on a conversion for 40 additional channels below #1, plus SKIP.....if possible will have in Vol 18.....DEC/JAN)

MECTRON ME-400 (MSM5807 PLL) 26.325-27.595MHz conversion...

A. Add Vcc to Pin 3 for lows.

B. Conditions - A and C

C. Open feed trace to Pin 2 for highs.

(Freq. chart below per selector position/above, 'new F₀'s mentioned only'.

	A	B	C		A	B	C	
1	26.325	26.645		21	26.575	26.895	27.535	
2	26.335	26.655		22	26.585	26.905	27.545	MODULATION
3	26.345	26.665		23	26.615	26.935	27.575	ADJUST VRS
4	26.365	26.685		24	26.595	26.915	27.555	
5	26.375	26.695		25	26.605	26.925	27.565	
6	26.385	26.705		26	26.625	26.945	27.585	
7	26.395	26.715		27	26.635	26.955	27.595	
8	26.415	26.735		28	26.645			
9	26.425	26.745		29	26.655			
10	26.435	26.755		30	26.665			
11	26.445	26.765		31	26.675			
12	26.465	26.785	27.425	32	26.685			
13	26.475	26.795	27.435	33	26.695			
14	26.485	26.805	27.445	34	26.705			
15	26.495	26.815	27.455	35	26.715			
16	26.515	26.835	27.475	36	26.725			
17	26.525	26.845	27.485	37	26.735			
18	26.535	26.855	27.495	38	26.745			
19	26.545	26.865	27.505	39	26.755			
20	26.565	26.885	27.525	40	26.765			

TRISTAR 747 - SLIDE MODIFICATIONS (2)

. . . . See OOP'S, this volume!

RE: Schematic on Vol 15, pg. 58 is the correct one for 747.

- Mod. #1
- A. Remove R18 (18K), no replacement.
 - B. Remove D7, no replacement.
 - C. Remove D6, replace with solid buss wire.
 - D. Remove R17 (68K), no replacement.
 - E. Replace D1 (Varactor Diode) with a 'Super Diode'.
 - F. Solder a Red wire from un-used terminal on the clarifier pot, to emitter of Q38 (9.4VDC). THAT's it....
- Mod. #2
- A. Disconnect D6 and D7's cathodes from PCB.
 - B. Disconnect the wire coming from the center terminal of the Clarifier pot at the PCB.
 - C. Connect this wire to where D6's cathode was removed; (or to point 7 on the crystal board).
 - D. Connect the unused terminal of the clarifier to Q38's emitter (9V Reg.).
 - E. On the crystal board, replace R7 (100K) with a 10K $\frac{1}{4}$ W 5% resistor.
 - F. If more slide is desired, place 'Super Slide' in series with D1's anode and ground. Or just replace D1 with a 'Super Diode'. THAT's it....

COBRA 25LTD (UPDATE)

Following changes add more power/modulation...

1. R76 (3.3K), change to 1K.
2. R53 (47K), change to 22K.
3. C89 (.033Mfd), change to 2.2Mfd (Note: make sure the + side isn't next to the I.C.).
4. If more drive is needed the final may be changed to 2SC1307 or ECG-236..

NOTE: Schematic of this unit is needed for our files...

This unit, according to my sources is the last type of SSB to be sold by Radio Shack; unless the trend of sales improves drastically! It is similar to the President AR144 and Cobra 146GTL, but people are still having problems with Kit #106. Have obtained such a unit for checkout of this and found that as usual - ignorance or laziness on part of individual who installed kit.

The kit does work, however have found that in this unit the VCO would not operate over the entire frequency range. Simple changing of D-25 in the VCO circuit eliminated all problems! 'Super Diode' to the rescue again.....following procedure is for installation of Kit #106 in the Realistic TRC-451 ONLY...

Kit #106 for TRC-451, uPD 2824C chip-ONLY

Installation instructions and 'Slide' modification

1. Kit will mount directly over the PLL chip with crystals facing rear of chassis (no need to drill chassis - only enlarge present hole in the cover)!
2. Kit wiring: Black - to nearest D.C. ground (used case of L8).
DON'T USE the case of any PLL circuit can or the filter....
White - to junction of C-72/L13 (see drawing):

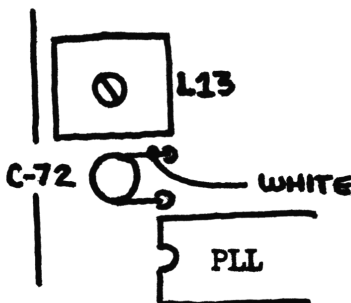

Red - 13VDC (B+), take from the ON/OFF switch, OFF side!
Check with VOM - was inside contact on this unit,
and wire colors are the same.

Brown - to CENTER contact on the clarifier pot.

Cut all wires to length after routing, then solder in place carefully!

3. Switch position-mounting with component side of PCB up so you can work on unit: Down-Low Fo; Middle-Normal CB Fo; Up-High Fo..
Using the Frequency Chart and both selector/kit switches for a reference: Adjust L-13 and L-14 only at this time to get the Fo's in.
(NOTE: IN THIS TEST UNIT; S/N: 130004XX, Run #3A1; had trouble getting the entire frequency range. If you have trouble, the solution is: Replace D-25 with a 'Super Diode'...had no further problem with entire modification.)
Once you get the frequency range in; tune L15, L40, L39, L38, L37, and L27; for overall LINEAR power output in SSB MODE!

This unit comes with the 'El Cheapo' Driver and Final, also '90-day wonder's'...suggest leaving them all until they go out, then change to 2SC1306/1307 and mica insulators. Unless you want to change now! All VR's adjustments are printed on the PCB...

A 'Slide' is required due to no trimmers being on the kit, and a SSB should have the capability anyway....

4. This 'slide' modification is for the TRC-451 ONLY!

- A. Remove R-422 (3.9K) on the Ch. Sel. PCB - replace with solid buss wire.
- B. Trace White wire from Clarifier pot to PCB - remove wire from that location. Pull wire out of the bundle and re-route to the etch side of board - solder to etch at spot indicated in drawing below:

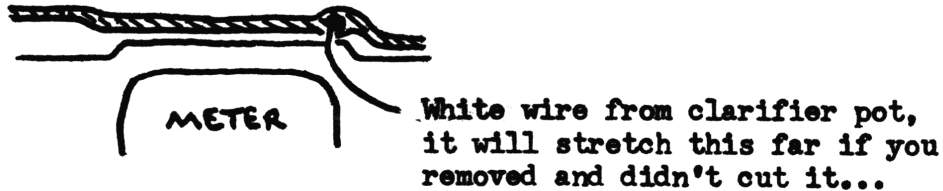

- C. Remove D-32 - no replacement...
 - D. Remove R-122 (15K) - no replacement..
 - E. (*) Remove D-31; replace with solid buss wire. Check out the slide in AM mode - regular CB Fo's, should be approximately: -2.5, +1.7KHz of the center..
 - F. (*-1) Replace D-30 with "Super Diode". Slide should now be approximately: -4.7, +4.9KHz of the center.
- PERFORM FOLLOWING IN NORMAL C.B. Fo's.....
- (*) Do following only if original varactor (D-30) is left in:
Put clarifier knob 'ident' to center position, adjust L-16 for center Fo in AM mode (Regular CB Fo's). Do the same in SSB modes but adjust USB (L-17) for 1KHz above center, and (L18) LSB for 1KHz below center. This way you have a starting point for SSB and a true center calibration for AM - but only in normal CB channels. Will have to slide for other switch positions.
 - (*-1) Do following only if you change D-30 to a 'Super Diode'.
Remove knob on the clarifier pot. Turn shaft fully CCW, adjust L-16 for -5KHz of the center frequency in AM mode, turn shaft fully CW, check to see if reading is +5KHz of center. (Balance out CCW and CW positions - using L-16). Turn shaft to center frequency and replace knob so that the 'IDENT' is at 12 o'clock position - recheck, might have to do a few times. Leave at center and adjust USB (L-17) for +1KHz above center Fo, adjust LSB (L-18) for -1KHz below center Fo. This will give you a true center for Normal CB operation, with 'slide' capabilities in SSB/AM.

The frequency chart is for use with switch installed in unit as write-up: See diagrams below.....

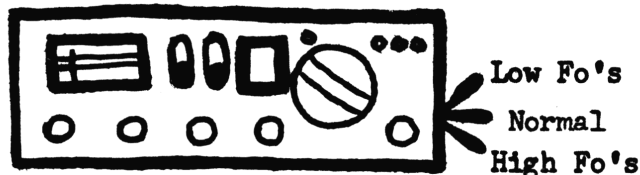

KIT #106 (TRC-451) FREQUENCY CHART

<u>Selector</u>	<u>LOW</u>	<u>NORMAL</u>	<u>HIGH</u>
1	26.515	26.965	27.415
2	26.525	26.975	27.425
3	26.535	26.985	27.435
4	26.555	27.005	27.455
5	26.565	27.015	27.465
6	26.575	27.025	27.475
7	26.585	27.035	27.485
8	26.605	27.055	27.505
9	26.615	27.065	27.515
10	26.625	27.075	27.525
11	26.635	27.085	27.535
12	26.655	27.105	27.555
13	26.665	27.115	27.565
14	26.675	27.125	27.575
15	26.685	27.135	27.585
16	26.705	27.155	27.605
17	26.715	27.165	27.615
18	26.725	27.175	27.625
19	26.735	27.185	27.635
20	26.755	27.205	27.655
21	26.765	27.215	27.665
22	26.775	27.225	27.675
24	26.785	27.235	27.685
25	26.795	27.245	27.695
23	26.805	27.255	27.705
26	26.815	27.265	27.715
27	26.825	27.275	27.725
28	26.835	27.285	27.735
29	26.845	27.295	27.745
30	26.855	27.305	27.755
31	26.865	27.315	27.765
32	26.875	27.325	27.775
33	26.885	27.335	27.785
34	26.895	27.345	27.795
35	26.905	27.355	27.805
36	26.915	27.365	27.815
37	26.925	27.375	27.825
38	26.935	27.385	27.835
39	26.945	27.395	27.845
40	26.955	27.405	27.855

Overall performance of the TRC-451 is good, with a solid 4W-AM, and 13.1W-SSB over the entire bandwidth is possible on a finely tuned unit...

Note: A 'Super Diode' was needed in this particular unit to make the VCO operate over the entire frequency range, but do not know if all will need this part..

M58472P PLL CHIP, (UPDATE)

This update was performed in same type unit as mod in Vol 16, pg. 33; GE 3-5801A. Isolate Pin 14 of the PLL chip - has no effect on Fo's in this condition! By taking Pin 14 to D.C. Gnd. thru a switch yields the following frequencies (All even). To get the odd frequencies must add capacitance or inductance to 11 series crystal. If you have a pair leave as-is; for a better commo set-up; (uncluttered Fo's)!

Selector	Fo	Selector	Fo	Selector	Fo	Selector	Fo
1	26.510	11	26.630	21	26.760	31	26.860
2	26.520	12	26.650	22	26.770	32	26.870
3	26.530	13	26.660	23	26.800	33	26.790
4	26.550	14	26.670	24	26.780	34	26.890
5	26.560	15	26.680	25	26.790	35	26.900
6	26.570	16	26.700	26	26.810	36	26.910
7	26.580	17	26.710	27	26.820	37	26.920
8	26.600	18	26.720	28	26.830	38	26.930
9	26.610	19	26.730	29	26.840	39	26.940
10	26.620	20	26.750	30	26.850	40	26.950

FORGOTTEN ACCIDENT

(Int.-withheld by request)..

Many years ago I discovered this by accident. Never thought of it again until some 'Hunters' wanted cheap conversion, and had old 23 ch. xtal rigs laying around to do it with...

This can be used on any 23 channel crystal unit with the following crystal set-up.

<u>TX & RX</u>	<u>TX Only</u>	<u>RX Only</u>
37.600	10.635	10.180
37.650	10.625	10.170
37.700	10.615	10.160
37.750	10.595	10.140
37.800		
37.850		

If you swap the 10Mhz Tx crystals; with the 10MHz Rx crystals; will get the following F_o's per selector position:

1 - 27.420	9 - 27.520	17 - 27.620
2 - 27.430	10 - 27.530	18 - 27.630
3 - 27.440	11 - 27.540	19 - 27.640
4 - 27.460	12 - 27.560	20 - 27.660
5 - 27.470	13 - 27.570	21 - 27.670
6 - 27.480	14 - 27.580	22 - 27.680
7 - 27.490	15 - 27.590	23 - 27.710
8 - 27.510	16 - 27.610	

Enjoy, new life for the old rigs, (a further conversion to FM would be ideal!).....

COBRA 148GTL-B, 60 Ch. AM/SSB - 02AG PLL: (EXPORT)

It seems that it is a 'jungle' at 'COBRALAND', and 2 versions of this unit may exist! Here we go again; just like the 148GTL-DX; but this may straighten some of it out.

The main discrepancy seems to be in the clarifier circuitry: The skematic I have available shows only one crystal (X-2, 10.0525MHz), in the circuit. Information received-says that there is sometimes two crystals and switching is done by the Tone switch or labeled Band HI-LO. Two different clarifier modifications exist also. With a discrepancy between them also: D6 and D7 (per schematic D6 is the one in direct feed from Clarifier pot.) Suggest lifting either one; if you lose transmit; that one stays in - remove the other.

The following 2 diagrams are for clarifier modification:

#1 (Sent in:)

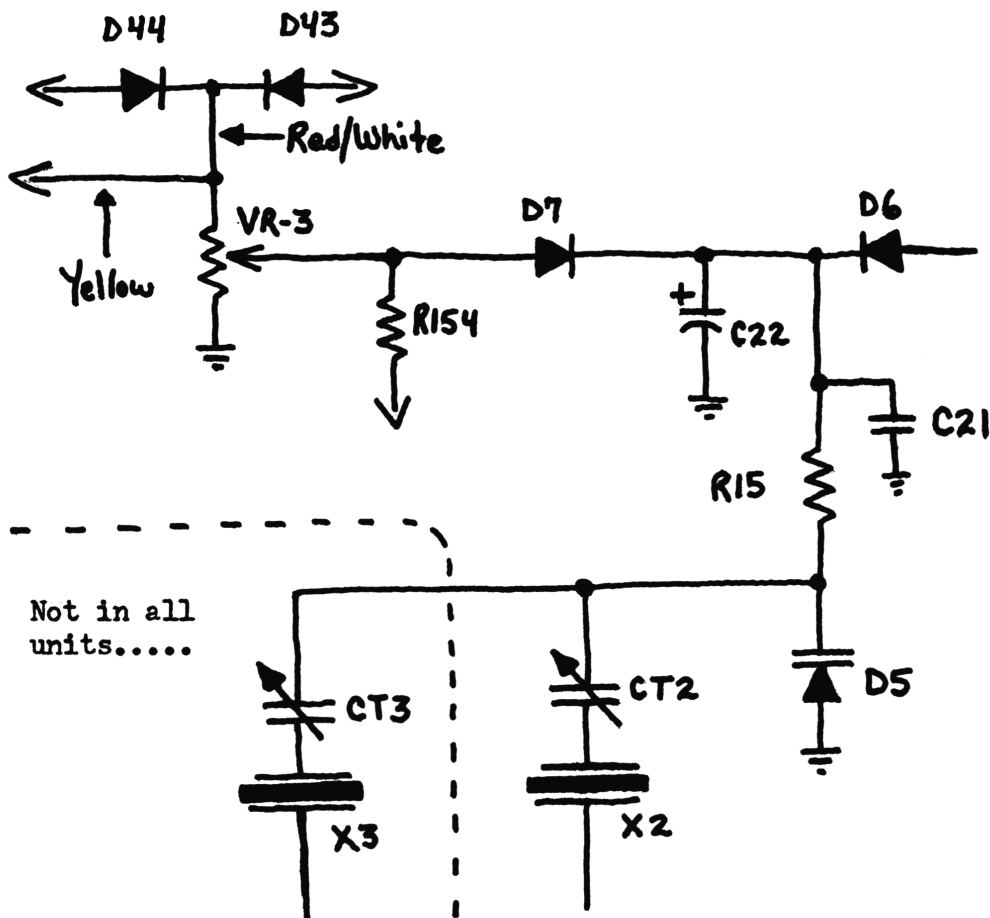

Cobra 148GTL-B (Export)...Cont.

#1. Cont...

- A. Remove Red/White and Yellow wires from clarifier pot, solder together and sleeve.
- B. Run a wire from where wires removed to the emitter of Q-28.
- C. Remove R154, no replacement.
- D. Remove D6, no replacement.
- E. REMOVE D7, REPLACE WITH SOLID BUSS WIRE.

#2. (Per Schematic/Theory)...Want some feedback on this for Vol. 18 if any discrepancies/additions...NOT TESTED OR PROVEN, as have no unit to work with!

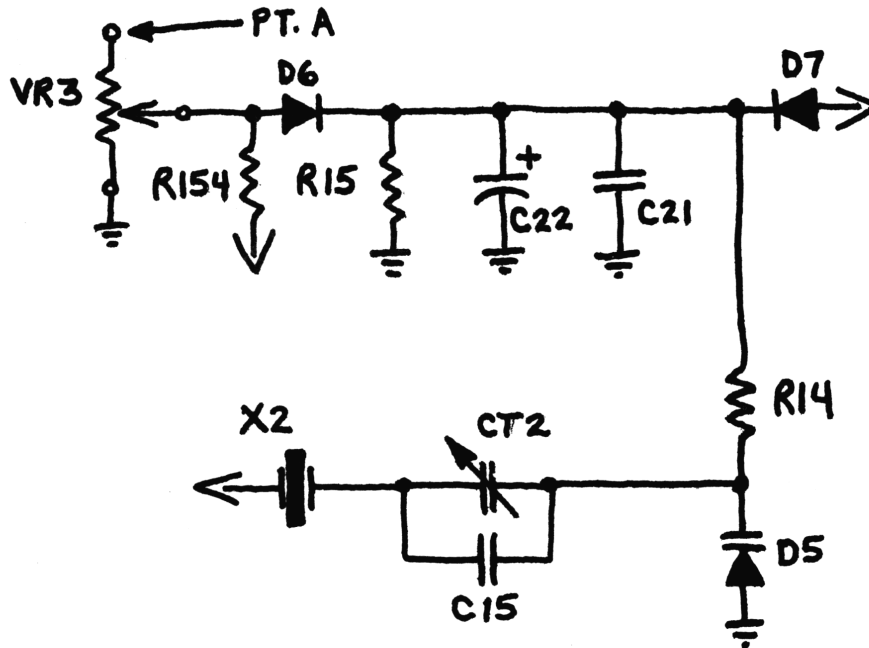

- A. Remove all wiring at PT. A (If more than one wire, solder all together and sleeve.)
- B. Run a new wire from Emitter of Q28 to PT. A....
- D6 → C. Remove D7, no replacement.
- D. Remove R154, no replacement.
- E. Unit should now 'slide' on transmit.... If it does, let's go
- D7 → the whole route: Remove D6 and replace with solid buss wire. Remove D5 and replace with 'Super Diode'. Remove VR3 and replace with 10-turn pot. Remove C15, no replacement.
- F. If you do everything in step E., use following adjustments for aligning the transmit F \emptyset to get a center on the pot, or any way you want... CT5 - LSB; CT6 - USB/AM; and CT2.
- G. Check the transistors for Mica type insulators, if not-replace.
- H. Change Driver and Final if you want to: 2SC1306 and 2SC1307. RV-4 is Final Bias (2SC1307 - set for 60ma).
- I. Check PLL logic levels on the following pins, schematic shows no connection: Pin 4 - Freq. Select Steps; 1-10KHz, 0-5KHz.
Pin 6 - Lock Detector
Pin 7 - P8 (256's bit) program pin.

Cobra 148GTL-B (Export)...Cont.

#2. Cont.

J. If Pin 4 has no connection, change logic state. (ground thru a 5.1K resistor; check for frequency changes on TX/RX.)

Note: This does not work all the time...If it does-plenty of extra switches on the front panel.

K. THIS IS PROVEN: Break feed line to Pin 9 of chip, with selector should now go: 27.615-28.245MHz.

PROVEN → L. Change R44 (270K), to 39K, if you are going to F ϕ expand the unit. Located near IC-4.

M. Don't forget Pin 7, and Pin 8 - which is tied high. Pin 8; break the line-bridge with 5.1K and switch at the pin to D.C. ground.

Remember: Feedback wanted on these mod's....as worked from schematic!

- NEW EXPORT MODELS -

COLT MDL.-510; AM/FM 120-Ch.

IDENTICAL to the Commtron XII, refer to it for all information.

COERA GTL-150; AM/FM/SSB

IDENTICAL to the Tristar 747, refer to it for all information.

NOTE: SCB still needs more information on either unit, Owner's Manual/Factory Service - have schematic..

PALOMAR MDL. 2400

1,200 TOTAL - Advertised channels! AM/SSB/FM/CW unit, with an "un-advertised DEALER PRICE of \$450"!..... SPECS are as follows: Cybernet Chassis, crystal switching for Freq. Rng. Shift; and the familiar "El-Cheapo" Driver/Final.

Freq. Selection in conjunction with LED Ch. Sel. and Band SW:

- Pos. 1: 26.065-26.505MHz
- 2: 26.515-26.955MHz
- 3: 26.965-27.405MHz
- 4: 27.415-27.855MHz
- 5: 27.865-28.305MHz
- 6: 28.315-28.755MHz

RF Gain: Operated by switching (local-mid-DX)...?

Clarifier: Variable Transmit + 5KHz; Coarse varies TX and RX,
Fine varies RX only.

Power Output Switch: Lo-1W, Middle-4W, High-7/8W in AM mode.
FM mode is 10W...

Meter: Standard - S/RF

Other switches - On/Off-Volume, Squelch, Mode, Tone, Tx/Rx-PA,
ANL, and NB.

PERSONAL OPINION: For \$450 dealer price should have at least the following:...SWR/Modulation/S/RF meter, Frequency Readout, and at least quality Driver and Final....

Schematic is printed in this volume....

COBRA 148 GTL-B

Schematic Diagram

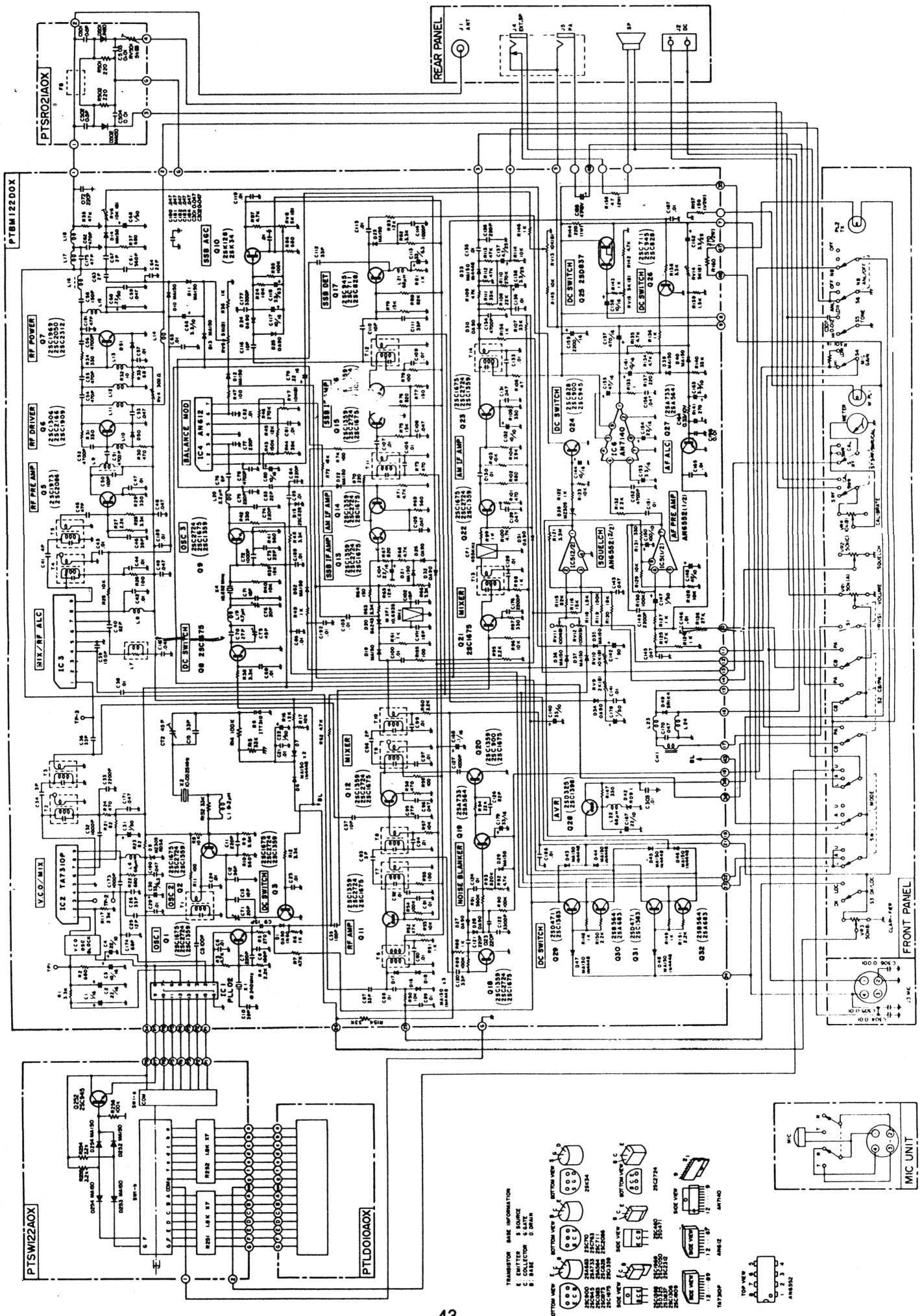

TRANSMITTER BASE INFORMATION
 E. EMITTER
 S. SOURCE
 C. COLLECTOR
 G. GROUND

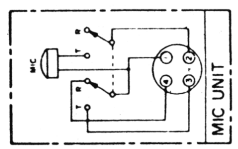
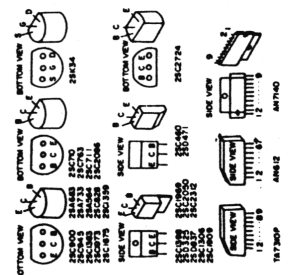

PALOMAR 2400

Schematic

NOTE: ALL VOLTAGES MEASURED FROM PC BOARD GROUND WITH D.C. VTM AT NO SIGNAL. VALUES OBTAINED ARE IN EXCESS OF ±2.0%. OF VALUES SHOWN THEN REASON FOR Δ TX, D LDR, (1) PC BOARD GND, Δ CHASSIS GND (TYPICAL VALUE SHOWN) * ADJUSTED

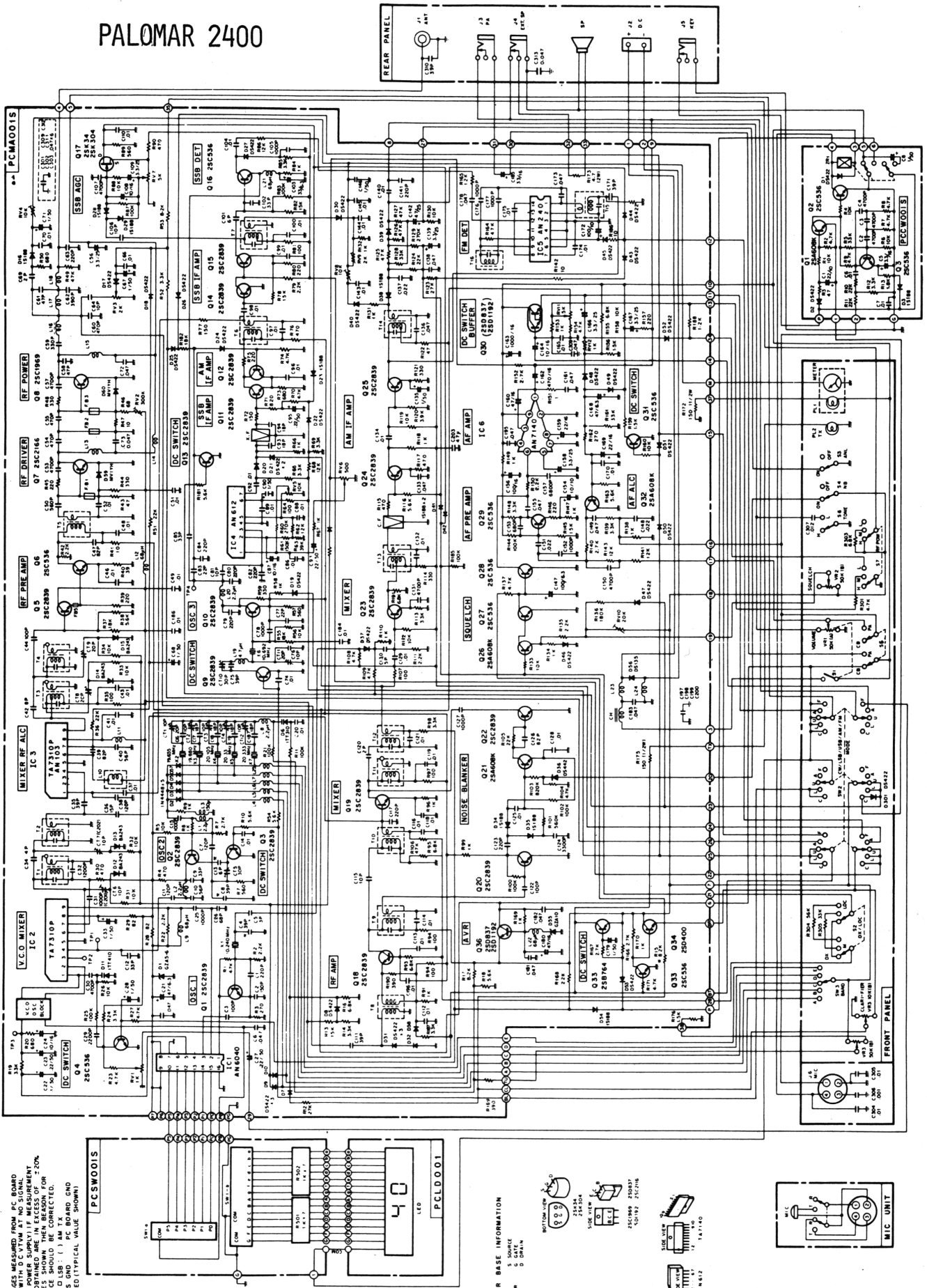

PALOMAR 2400

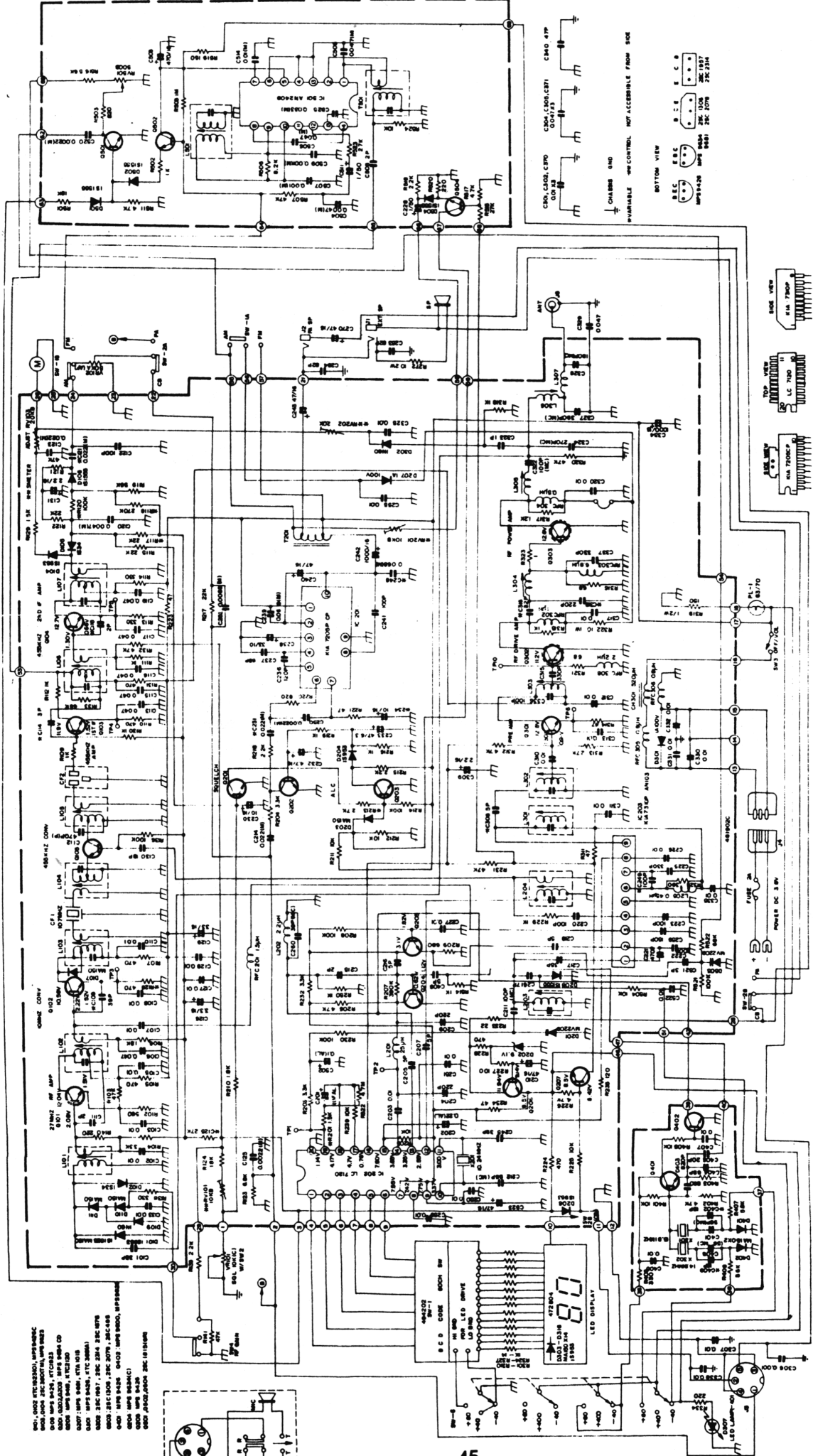

HINTS / KINKS / GOOFS

Have received great response to this column. Some items sent in were utilized elsewhere, as more of SERVICE/UPDATE nature.

(Remember items in H-K-G; do not receive a free volume; also this column is not indexed...)

Realistic PRO-2002 50-Ch. Prog. Scan.: There is a mod. for this unit! BUT - you lose the 30-50MHz band permanently at this time... When a solution to this problem is found will print the mod. (BW)

Problem: 02A AM Chassis: Low Power, Reverse Mod., when expanding the F_o's.
Solution: Replace C4 (68pf) with 100pf, replace C22 (2pf) with 5pf.....

Problem: 858 SSB Chassis: Warble on 'uppers', O.K. on normal F_o's in the SSB mode?

Solution: Readjust the VCO (L-17) a hair...Don't insert 3.3K resistors in series with C140/141 as some techs do!

Problem: 148GTL-DX: Regulator Circuit Transistors, hard to find?

Solution: TR-51, 2SA1012: ECG-378. TR-50, 2SB525: ECG-294.

Vol. 13, Pg. 52-55: Re.-Gunn Oscillator...CHEAP SOURCE FOUND--Radio Shack 'Household Burglary Warning System' #49-320. Has a 10GHz Gunn Oscillator AND a 12V/1.2AH Gel Cell inside! (Units are discontinued and often discarded by stores-as uneconomical to repair! I bought one for \$2.00)! Red wire is B+, Black wire is DC Gnd.. DON'T adjust the Gunn cavity screws unless you have a good Spectrum Analyzer! Will have to back out the two screws on the feed horn for a good Tx pattern (BW). Note: See Regulated Voltage/Current project in this issue...

Problem: Teaberry Stalker 9 (Export): Low Modulation?

Solution: Remove TR-32 SCB STILL NEEDS SCHEMATIC ON THIS UNIT.....

HAZAROUS TO YOUR HEALTH: The common practice of running a mobile inside the house with car battery.. Re-charging a battery has a very dangerous by-product - HYDROGEN GAS! One spark, and you might not be able to read SCB anymore.... Go buy a good regulated power supply....

Wanted: Low F_o mod for Teaberry Model T (4011); Buy Vol.16, pg. 41; See Bristol BCB-2271....

Feedback: Re-"MY WAY SLIDE", Vol 16 pg 38. I didn't believe it either so 'borrowed' back a modified unit that converted 3 years ago. Worked like a charm - had to put a 10-turn pot in unit - also got a little less on the upswing; (ONLY 21.4KHz - Colt 1200, Excalibur)....

Courier-Centurian 40D; Re: Vol 10 pg.53, I24 alignment is extremely critical...be very careful when broadbanding, double-check the SSB TX!

When Junking-out the Junker's that are un-economical to repair: Remove the following and put in a plastic bag marked with Make/Mil. Coils, Chips, Zener's, Wire-wound's, Switches, etc...Have found it to be better than having 50+ units laying around...I use them for LandFill!

RE: Above idea - This is another reason for the Newsletter being needed as factory doesn't have parts, and if they do usually is a back-order item. I had to send back a TRC-57 to customer because the factory didn't have a VCO block (sealed unit), I was out the repair bill and he's out a radio - also everyone was out because had the go-ahead to do a full blown mod on unit for write-up to clear up the problem with modification!

---148GTL-DX (Early-Late) - FACTS---

BAM

EARLY: A. S/N Range: 03000001-4498 to 13000001-1504

B. PLL Chip is MB8719

C. Crystal switching for LOW/MID/HIGH F_0 ranges.

(for further frequency increases the the standard 8719 modification may be utilized. *Or just switch the crystals.)

*Here is a discrepancy that would like to get cleared up as haven't run across an 'Early' unit to check it. If anyone can help on this; please do; and give serial no. of unit. (XX- the last two numbers!).

1. Schematic shows X-2 as 15.03MHz; X-3 as 15.48MHz; and X4 as 15.93MHz....if this the case 14.58MHz will take you down another 40 ch., and 16.38MHz will take you up 40 more..

2. Board layout diagram and Block diagram show X-2 is 15.48MHz; X-3 is 15.93MHz; and X-4 is 16.38MHz.... to go down another 40 ch. use 15.03MHz, and 16.83MHz for additional higher channels.

Of the 6 units I have seen all were 'Late' DX's, haven't even heard of anyone having an 'Early' yet.....

Good

LATE: A. S/N Range is above 13000001-1504

(Unit utilized for modification in Vol. 15 was #13015XX.)

B. ALL, (with exception of line-up) published in Vol. 15 and Vol. 16 of SCB was for 'Later' version (See OOP's this Vol.).

C. PLL Chip is MCL45106P; with 2 - MCL4008ECP, 4-bit full adders to accomplish logic switching via selector/range switch.

D. PLL Pinout below:

(Chip B+)Vdd--1	18--Vss(D.C. Gnd)
F in--2	17--Po
Osc in--3	16--P1
Osc out--4	15--P2
$\frac{1}{2}$ Osc--5	14--P3
* F_0 select--6	13--P4
\emptyset Det--7	12--P5
Lock Det--8	11--P6
P8--9	10--P7

*Logic 1=10KHz steps, Logic 0=5KHz steps, -SOMETIMES!!

Using above and information in Vols 15 & 16, can 'custom' modify the unit as you see fit with no problem... known frequency ranges on some 'Late' units are from 25.785MHz to 28.245MHz..Power output linearity??

BURGLAR ALARM

This is to answer requests; and questions; as to why SCB has not published Burglar Alarm Schematics sent in! The main reason is that not associated with communications. I personally have seen over one dozen different designs sent in by individuals, some are very good-complex, costly, etc. But printing them all would take up too much room, and don't have it to spare! So instead have printed just one simple, PROVEN, and cheap to build unit..

I know this alarm, and back-up supply for home use works! Have had it in my home for over 6 years with no failure or repair! Current drain on this curcuit is about .5A when activated, the AC supply has battery back-up for use in case of power failure.

AC Supply, Back-up Skem.

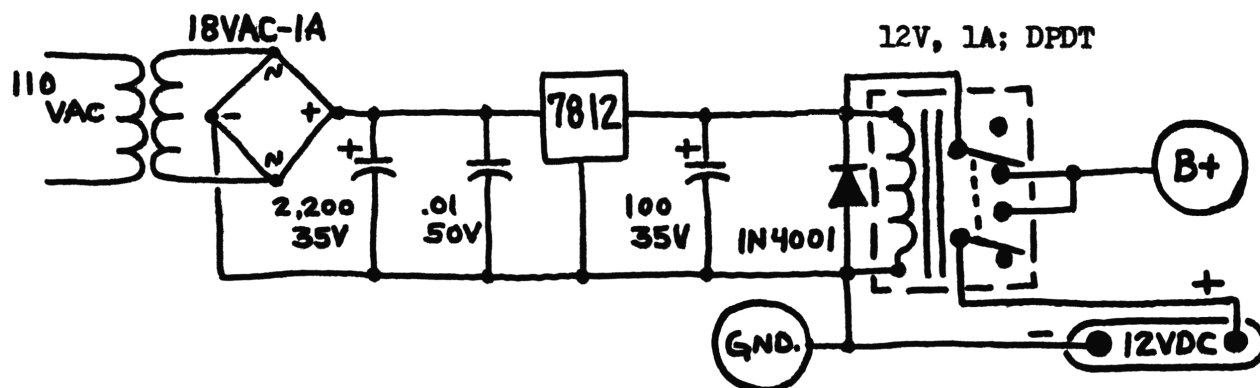

Alarm Schematic

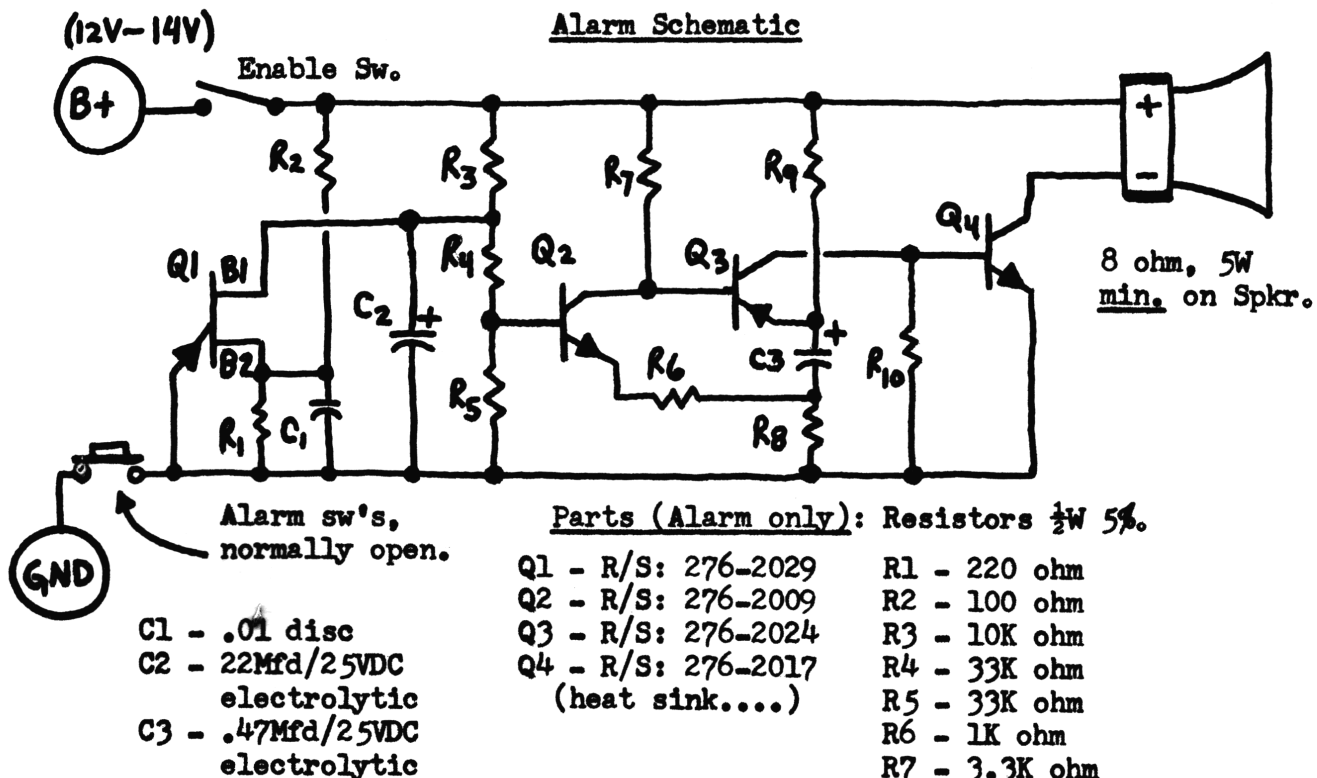

NOTE: Alarm switches can be in parallel, any number.....

CUSTOM REGULATED (VOLTAGE & CURRENT) POWER SUPPLY

This is another "Quality" piece of test equipment for bench use. I.C. Chip (LM317), limits are 37VDC and 1.5Amps. Design limits of power supply give plenty of "Coasting" room; for maximum use; and minimum repair. (My own initial unit has been running for 5½ yrs, with no repair necessary!)

I utilized a Radio Shack Metal Cabinet #270-253 to build entire unit. The base of case served as heat sink for both IC's and bridge rectifier. A panel mount fuse holder was also used-on the front. (Since then I have built a larger unit, utilizing the same basic design. - ± 35V, 3A with voltage/current meters.)

Skematic is in 2 sections: Regulated Adjustable Power Supply, and Adjustable Current Regulator.

Theory of Operation

Reg. P/S: R1 is voltage output adjustment, (adjust for minimum voltage). At minimum voltage should read 1.2VDC or less! If not, change value of R2 until it does..(put 500 ohm adjustable resistor in place-vary until you get 1.2VDC or less-remove and measure the resistance. Insert that value resistor into R2 position, DO NOT leave the variable resistor in place!). The reason for have 1.2VDC or less minimum-Nickle Cadmium batteries are 1.2V and can deep-cycle just one if needed. (D3, R3 is bleeder network...)

Switch S2: for non-current regulation of voltage output. (D4 is to prevent 'feedback' to power supply from item being powered.)

Current Regulator: This is drawn separately as may want to incorporate into any existing equipment on hand. Voltage in/out is the same, only the current is regulated/adjustable by R4, at 1.5A MAX. Current is read with either external or built-in meter - your choice.

This unit is not hard to build, most parts can be found in the 'Junk box', but have added Radio Shack P/N's to most items. DO NOT DE-RATE the parts' voltage/current ratings!.....

Parts List: IC 1, 2 - LM317 (TO-220), R/S 276-1778
F1 - 2A Fast Blow, R/S 270-1275
T1 - 117VAC Pri/25.2VAC Sec-3A, R/S 273-1151
B1 - 6A/50PIV Full Wave Bridge, R/S 276-1180
C1 - 4,000MFD/50VDC Electrolytic-MINIMUM (may have to parallel 2-2000Mfd/50V) R/S 272-1048
C2 - .1Mfd/150V disc, R/S 272-1053
C3 - .01Mfd/150V disc, R/S 272-1051
C4 - .47/50VDC Electrolytic, R/S 272-1433 (O.K. on 35V)
C5 - 22Mfd/50VDC " R/S 272-1014 "
C6 - 47Mfd/50VDC " R/S 272-1015 "

Reg. (E & I) P/S: (Cont.)

- Parts List: R1 - 5K Pot, Linear Taper, R/S 271-1714*
 R2 - 220 ohm $\frac{1}{2}$ W 10%, R/S 271-015
 R3 - 2.2M ohm $\frac{1}{2}$ W 10%, R/S 271-061
 R4 - 10K Pot, Linear Taper, R/S 271-1715
 D1, D2 - 1N4003 (minimum), R/S 276-1102
 D3 - Red (any color will do) L.E.D., R/S 276-041
 D4 - 1N5400 (minimum), R/S 276-1141
 S1 - SPST, 3A/117VAC, R/S 271-1740*
 S2 - SPDT, 6A/117VAC, R/S 275/654
 J1-J4 - Insulated Binding Posts (R/S 274-661 has 2 sets)
 J5, J6 - Optional, or add an Ammeter, 2A...
 *On-Off sw, clips to back of pot...
 Misc: Case, fuse holder, IC mounting hardware, Perf. board, standoffs, wire, etc.....

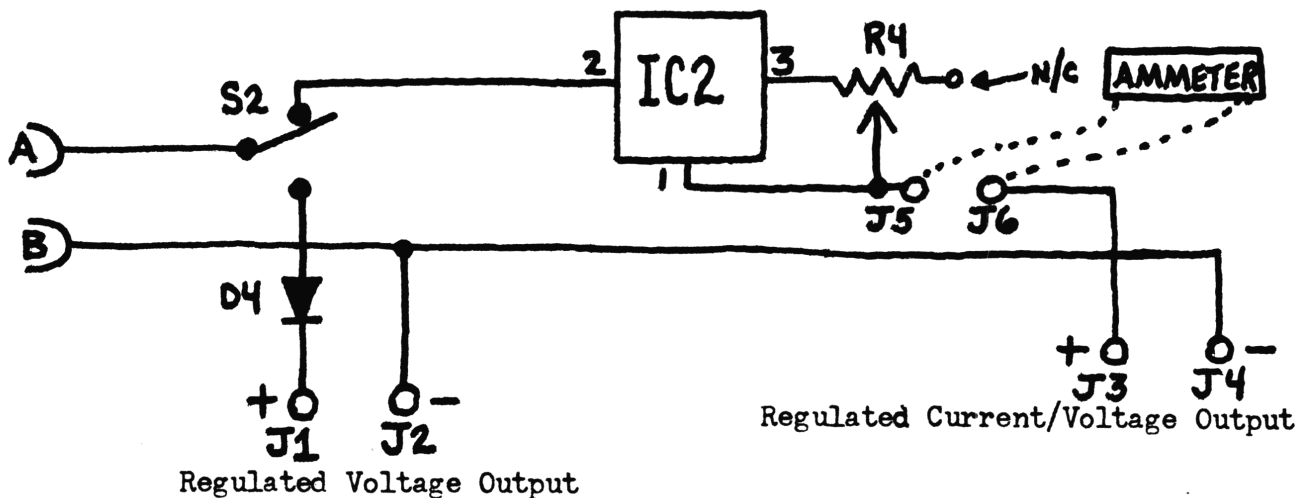
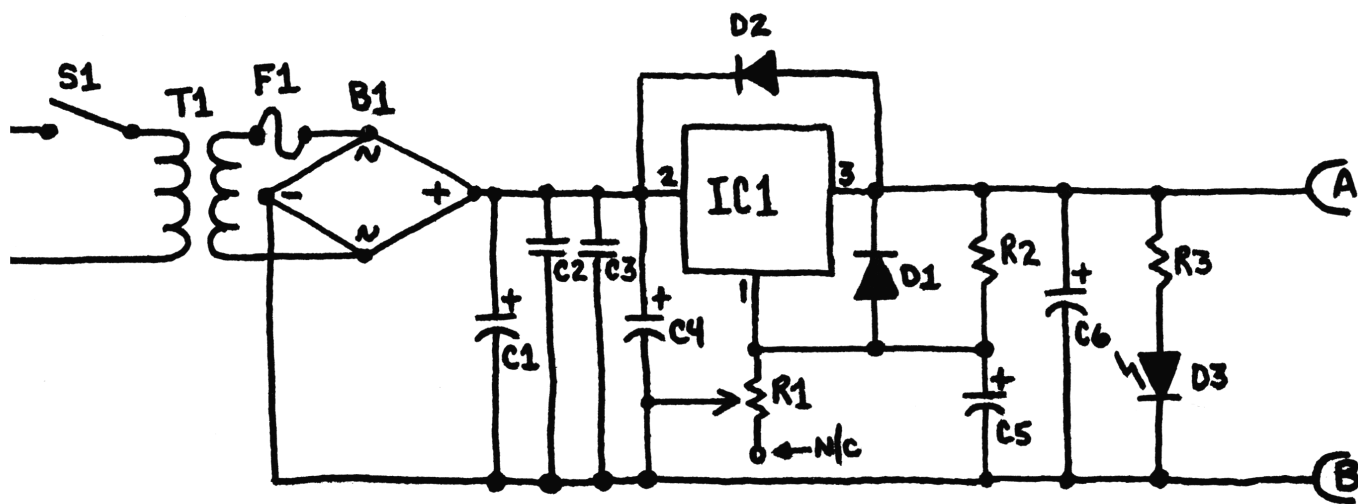

GYPsy Frequency Chart

Frequency	Code	Selector	Frequency	Code	Selector	Frequency	Code	Selector
25.155	B-R	10	25.765	Y-B-R	36	26.375	B-Y	33
25.165	B-R	11	25.775	Y-B-R	37	26.385	B-Y	34
25.185	B-R	12	25.785	Y-B-R	38	26.395	B-Y	35
25.195	B-R	13	25.795	B	10	26.405	B-Y	36
25.205	B-R	14	25.805	B	11	26.415	B-Y	37
25.215	B-R	15	25.825	B	12	26.425	B-Y	38
25.235	B-R	16	25.835	B	13	26.435	R	10
25.245	B-R	17	25.845	B	14	26.445	R	11
25.255	B-R	18	25.855	B	15	26.465	R	12
25.265	B-R	19	25.875	B	16	26.475	R	13
25.285	B-R	20	25.885	B	17	26.485	R	14
25.295	B-R	21	25.895	B	18	26.495	R	15
25.305	B-R	22	25.905	B	19	26.515	R	16
25.315	B-R	24	25.925	B	20	26.525	R	17
25.325	B-R	25	25.935	B	21	26.535	R	18
25.335	B-R	23	25.945	B	22	26.545	R	19
25.345	B-R	26	25.955	B	24	26.565	R	20
25.355	B-R	27	25.965	B	25	26.575	R	21
25.365	B-R	28	25.975	B	23	26.585	R	22
25.375	B-R	29	25.985	B	26	26.595	R	24
25.385	B-R	30	25.995	B	27	26.605	R	25
25.395	B-R	31	26.005	B	28	26.615	R	23
25.405	B-R	32	26.015	B	29	26.625	R	26
25.415	B-R	33	26.025	B	30	26.635	R	27
25.425	B-R	34	26.035	B	31	26.645	R	28
25.435	B-R	35	26.045	B	32	26.655	R	29
25.445	B-R	36	26.055	B	33	26.665	R	30
25.455	B-R	37	26.065	B	34	26.675	R	31
25.465	B-R	38	26.075	B	35	26.685	R	32
25.475	Y-B-R	10	26.085	B	36	26.695	R	33
25.485	Y-B-R	11	26.095	B	37	26.705	R	34
25.505	Y-B-R	12	26.105	B	38	26.715	R	35
25.515	Y-B-R	13	26.115	B-Y	10	26.725	R	36
25.525	Y-B-R	14	26.125	B-Y	11	26.735	R	37
25.535	Y-B-R	15	26.145	B-Y	12	26.745	R	38
25.555	Y-B-R	16	26.155	B-Y	13	26.755	Y-R	10
25.565	Y-B-R	17	26.165	B-Y	14	26.765	Y-R	11
25.575	Y-B-R	18	26.175	B-Y	15	26.785	Y-R	12
25.585	Y-B-R	19	26.195	B-Y	16	26.795	Y-R	13
25.605	Y-B-R	20	26.205	B-Y	17	26.805	Y-R	14
25.615	Y-B-R	21	26.215	B-Y	18	26.815	Y-R	15
25.625	Y-B-R	22	26.225	B-Y	19	26.835	Y-R	16
25.635	Y-B-R	24	26.245	B-Y	20	26.845	Y-R	17
25.645	Y-B-R	25	26.255	B-Y	21	26.855	Y-R	18
25.655	Y-B-R	23	26.265	B-Y	22	26.865	Y-R	19
25.665	Y-B-R	26	26.275	B-Y	24	26.885	Y-R	20
25.675	Y-B-R	27	26.285	B-Y	25	26.895	Y-R	21
25.685	Y-B-R	28	26.295	B-Y	23	26.905	Y-R	22
25.695	Y-B-R	29	26.305	B-Y	26	26.915	Y-R	24
25.705	Y-B-R	30	26.315	B-Y	27	26.925	Y-R	25
25.715	Y-B-R	31	26.325	B-Y	28	26.935	Y-R	23
25.725	Y-B-R	32	26.335	B-Y	29	26.945	Y-R	26
25.735	Y-B-R	33	26.345	B-Y	30	26.955	Y-R	27
25.745	Y-B-R	34	26.355	B-Y	31	26.965	None	1
25.755	Y-B-R	35	26.365	B-Y	32	26.975	None	2

GYPSY Frequency Chart (Cont.)

Frequency	Code	Selector	Frequency	Code	Selector	Frequency	Code	Selector
26.985	None	3	27.275	None	27	27.565	Y	25
26.995	Y-R	31	27.285	None	28	27.575	Y	23
27.005	None	4	27.295	None	29	27.585	Y	26
27.015	None	5	27.305	None	30	27.595	Y	27
27.025	None	6	27.315	None	31	27.605	Y	28
27.035	None	7	27.325	None	32	27.615	Y	29
27.045	Y-R	36	27.335	None	33	27.625	Y	30
27.055	None	8	27.345	None	34	27.635	Y	31
27.065	None	9	27.355	None	35	27.645	Y	32
27.075	None	10	27.365	None	36	27.655	Y	33
27.085	None	11	27.375	None	37	27.665	Y	34
27.105	None	12	27.385	None	38	27.675	Y	35
27.115	None	13	27.395	None	39	27.685	Y	36
27.125	None	14	27.405	None	40	27.695	Y	37
27.135	None	15	27.425	Y	12	27.705	Y	38
27.155	None	16	27.435	Y	13			
27.165	None	17	27.445	Y	14			
27.175	None	18	27.455	Y	15			
27.185	None	19	27.475	Y	16			
27.205	None	20	27.485	Y	17			
27.215	None	21	27.495	Y	18			
27.225	None	22	27.505	Y	19			
27.235	None	24	27.525	Y	20			
27.245	None	25	27.535	Y	21			
27.255	None	23	27.545	Y	22			
27.265	None	26	27.555	Y	24			

Code: Y - Yellow
 B - Blue
 R - Red

Transmit - Receive Frequencies may be anywhere within the GYPSY chart.

Maximum Bandwidth of unit is usually 1.5MHz.....

GYPSY - AM Unit 25.155-27.705MHz 02A/G PLL chip chassis..

These units are modified in such a way that the bandwidth is 'field-tunable' with minimum of equipment anywhere within the "GYPSY" range. Usually can be re-tuned; Tx and Rx in less than 5 minutes..... Survivalist's are the persons most likely to have these units.

NOTE: "Custom Conversions" has 2 new kits for the 'GYPSY' frequency range.

- #83-1; 25.155-26.425MHz 116-channel.
- #83-2; 26.115-27.405MHz 118-channel.

!! ORDER THESE KITS FROM SELMAN ENTERPRISES - KITS #83-1 & #83-2!!

TRAM D201/201A; SERVICE NOTES

by G.B.

I buy, rebuild, and sell; a lot of Tram D201/201A's.

One common problem on both units is located on the receiver board. I have found on most that resistors; R502, R503, R507, and R508 are mounted too close to the PCB. (I replace them, and mount $\frac{1}{2}$ " above the board - for heat disappation, and protect the PCB.)

On D201 (23 ch.); I remove the 2-47K 3W Metal Oxide resistors; R-418 and R-419.. Replace each with 2-100K 2W resistors in parallel, mounted $\frac{1}{2}$ " above board. See Drawing:

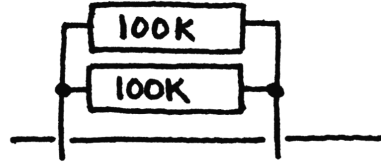

BA BOARD: Measure values of R-638/R-639 (220 ohm 2W); also R-611/R-612/R-613 and R-614 (10K 2W). Replace if needed with 2% tolerance and mount off PCB.

AUDIO BOARD: R-6, 100 ohm 7W wire wound. If mounted flat on PCB, lift $\frac{1}{4}$ " to permit air flow. NOTE—make sure BA Board seats properly afterwards.

TRAM XLR 23 Ch. SSB

For extra channels, use crystal charts: SCB Vol. 1 and 2 (Y201-Y206).
Slider Mod: Tie Green wire from wiper of clarifier pot to junction of R222/L203. Remove R228 completely; replace CR-203 with "Super Diode"; also add a "Variable Choke" (2-8uH) in series with Anode to D.C. Grnd. Adjust choke for desired slide range.... R616-AMC (defeat C611, 4.7Mf electrolytic), ALC-R130, Mike Gain-R617, Adjust L108, L106 for max forward drive on LSB, with 1KHz audio input to mike.

PUBLISHER'S NOTE

We have been getting some requests for crystal rig modifications. To do this "reprinting" would be a dis-service. Obtain SCB Vol 1 & 2.

COBRA 148GTL-DX (LATE) - UPDATE

Both of these modifications are proven....

1. Pin 6 of PLL chip has no connection...take to D.C. ground thru a switch. (Plenty of switches on the front that can be hard-wired, and used for switching puposes.)

Yields these new frequencies on: LOW... 26.555-26.775MHz

MID... 26.780-26.960MHz

These new frequencies are in 5KHz steps!

2. Change the original crystal X-2 (15.0000MHz) to a 15.4800MHz crystal. This changes the main bands: Low/Mid/High to the following frequency ranges: Low - 26.965-27.405MHz

Mid - 27.415-27.855MHz

High - 27.865-28.305MHz

New Truth Table for TP-3, vs. old: with the crystal change...

Old	L	M	H	New	L	M	H
AM	15.8200	16.2700	16.7200	AM	16.2700	16.7200	17.1700
USB	15.8225	16.2725	16.7225	USB	16.2725	16.7225	17.1725
LSB	15.8175	16.2675	16.7175	LSB	16.2675	16.7175	17.1675

UPDATE: TRC-448, 'Expanded Slide'

If you have done the Custom Conversion in Volume 16, pg. 25-30 and not satisfied with the slide: Do the following steps 24A-C.

24-A. Remove R32 and R39, both (47K): no replacement.

B. Remove TC4 and TC5: no replacement.

C. Suggest 'Super Slides' instead of 'Super Diodes' in this particular unit, for bigger swing.

If you have not done the "Custome Conversion" in Vol. 16! Obtain a copy, and follow Steps 17-24 on page 28. (Will also need 8" of Blue wire); then follow steps 24A-C printed above.

DO NOT REPLACE D13 or D14 with solid buss wire!

----- 148GTL-DX (LATE) ALIGNMENT PROCEDURES -----

(Note: You have an 'Early' unit if serial number is between the following ranges: 03000001-4498 to 13000001-1504) Secret C.B. Vol. 16, has complete alignment procedures, for the 'Early' version.

Complete Alignment Procedures for the 'Late' Version of 148GTL-DX

PLL/OSCILLATOR ALIGNMENT

Equipment Needed: Oscilloscope, D.C. Volt Meter, Frequency Counter..

Step	Control Settings	Adjust	Perform/Check for
A	Mode: RX Band: MID Mode: AM Voice Lock-Center CH: 19	L17	Connect Oscilloscope to TP-4 (lead of R124). Adjust for Max. reading
B	Same as above, CHANGE to: CH: 40	L18	Connect DC Volt Meter to TP-2 (Lead of R126). Adjust for 5.4 Volts..
C	Step A Settings	L19	Connect Oscilloscope to TP-3 (Lead of R84). Adjust for Max reading
D	Step A Settings	L21	Frequency Counter to TP-3 (lead of R-84). Adjust for 16.490MHz
E	Step A Settings, CHANGE to: Mode: USB	L22	Leave Frequency Counter as is... Adjust for 16.4925MHz
F	Step A Settings, CHANGE to: Mode: LSB	L23	Leave Frequency Counter as is... Adjust for 16.4875MHz
G	Step A Settings, CHANGE to: Mode: LSB Band: MID	VR6	Leave Frequency Counter as is... Adjust for 16.4875MHz, (Recheck Step F.....)
H	Step A Settings, CHANGE to: Mode: CW	L37	Frequency Counter to TP-6 (Lead of R60). Adjust for 10.695MHz

148GTL-DX...PLL/OSCILLATOR ALIGNMENT...Cont.

Step	Control Settings	Adjust	Perform/Check for
I	Step A Settings, CHANGE to: Mode: USB	L38	Leave Frequency Counter as is... Adjust for 10.6925MHz
J	Step A Settings, CHANGE to: Mode: LSB	L39	Leave Frequency Counter as is... Adjust for 10.6975MHz

End of PLL/OSC. alignment...

- - - RECEIVER ALIGNMENT - - -

Equipment Needed: Sig. Gen.(27MHz Band, 1000Hz, 30% AM Mod., 1KHz-1.5KHz Dev. FM Mod.); Audio VTVM, Oscilloscope, Dummy Load (8 ohm, 5W resistive), D.C. Power Supply...

Step	Control Settings	Adjust	Perform/Check for
A	CH: 40 BAND: Low NB/ANL: Off MODE: AM Voice Lock-Center SQ: Max, CCW TONE: Hi RF GAIN: Max, CW CH 9: Off	None	Double check all settings
B	Same as Step A	L8	Turn core to bottom..
C	Step A Settings, CHANGE to: Mode: AM Band: LOW CH: 19	L4, L5, L7, L9, L11, L12, L13..	Adjust for Max readings, and then readjust using L8 for maximum again...
D	Step A Settings, CHANGE to: Mode: USB Band: LOW CH: 19	L14, L15	Adjust for Max. readings..
E	Step A Settings, CHANGE to: Band: MID Mode: USB NB/ANL: ON	L1, L2	Set Sig Gen on Ch. 39, 27.395MHz. With no-modulation. Connect O-scope to TP-1 (Lead of D2) and adjust coils for Max reading on O-Scope. Set level of Sig Gen to 5uV, then readjust this step.
F	Step A Settings	VR4 for AM/FM... VR3 for SSB/CW..	Set the Sig Gen to Ch. 40, 27.405MHz 30% AM Modulation with 1000uV. Then turn VR4, so that the AF signal is on scope(at TP-1). Repeat for SSB/CW mode with VR3.

148GTL-DX...RECEIVER ALIGNMENT....Cont.

Step	Control Settings	Adjust	Perform/Check for
G	Step A Settings	VR1 for AM/FM... VR2 for SSB/CW..	Set Sig Gen to CH. 40, 27.405MHz no modulation. Level of Sig Gen 100uV. Adjust VR1 for S-9 reading on radio's meter. Repeat for VR2 by adjusting in SSB/CW mode.
H	Step A Setting, CHANGE to: Mode: FM	I6	Set Sig Gen to 1mv with 1.5KHz of deviation of 1KHz, adjust I6 for Max. sinewave output on O-scope.

End of RECEIVE Alignment...

- - - TRANSMITTER ALIGNMENT - - -

Equipment Needed: VTVM (Full scale, 1V DC with RF Probe); RF Output Power Meter; Spectrum Analyzer; Frequency Counter (30MHz); D.C. Power Supply (Regulated 13.8V, 4A); 50 ohm load and attenuator; O-Scope(30MHz); AF Oscillator; DC Ammeter...

Step	Control Settings	Adjust	Perform/Check for
A	Mode: TX Band: MID CH: 19 Mode: USB Mic. VR: CW CH 9: OFF Coarse: CENTER	VR11	Remove PC-834 (PCB) and connect DC Ammeter to TP9 (+) and TP8 (-). Adjust for 50ma reading.
B	Step A Settings	VR10	Connect DC Ammeter to TP9 (+) and TP7 (-), and adjust for 50ma.
C	Step A Settings CHANGE to: Mic input 30mV 1KHz.	VR12, L53...	Restore PC-834. Turn VR12 to Max CW.. Turn core of L53 to bottom..
D	Same as above.. <u>MAKE NO CHANGES</u>	L52, L54, L55,	Adjust for Max reading on RF VTVM
E	Same as above.. <u>MAKE NO CHANGES</u>	L53	Set the Band Sw: HI, CH 40, and adjust for max reading on RF VTVM. Set the Band Sw: LOW, CH 1, readjust for minimum difference in output power...

148GTL-DX...TRANSMITTER ALIGNMENT...(Cont.)

Step	Control Settings	Adjust	Perform/Check for
F	Step A Settings CHANGE to: Mode: AM Mic input 90% modulation	I44	Adjust for Max reading on RF VTVM
G	Step A Settings CHANGE to: Mic input 30mV 1KHz	VR12	Adjust for 24.5V reading on RF VTVM
H	Step A Settings	VR7	Adjust for Min reading on Spectrum Analyzer for USB and LSB.
I	Step A Settings CHANGE to: Mode: AM	VR13	Adjust for 5.0W on RF Power Meter
J	Same as above.. <u>MAKE NO CHANGES</u>	VR8	Set the meter SW to S/RF position. Adjust VR8, so that the radio's meter reads 5W (Between Green and Red zones).
K	Same as above.. ---CHANGE:----- Mic input to 30mV	VR14	Adjust for 90% modulation on scope
L	Step A Settings CHANGE to: Mode: FM CH: 40 Mic input 30mV	VR5	Adjust for 5KHz deviation
M	Same as above.. ---CHANGE:----- Mode: CW	VR15	Adjust for 0.2V reading on AF VTVM when CW key is keyed
N	Step A Settings CHANGE to: CH 9 SW; CH 9		Confirm output F_o - 27.065MHz...

End of TRANSMIT Alignment...

This completes the 148GTL-DX (LATE VERSION) alignment procedure.....

SPECIFIC TUNE-UPS

Gemtronics GTX-3323: VR152 - AGC; VR151 - S Mtr.; VR491 - RF Mtr.;
VR181 - Sq. Rng.; VR481 - AMC (Don't defeat)
TX - I431, I432, I433, I441, I451, I463, I464
RX - L111, L112, L121, L122, L131, L141, L151

Midland 102M (77-102)

RV102 - S Meter; RV202 - RF Meter; RV101 - Sq. Range; The other
unmarked pot is for AMC adjustment. (Do not defeat)....

PLL CHIPS

Following is list of identical pin-outs for chips — this is
not to say that all will modify the same way or PLL logic B+'s are
also:

MB8719, MB8734

MC145104, MM55104, MN6040A, SM5104, 00S09

MC145106, MM55106, MM55116, MM55126

MC145107, MM55107, SM5107

MM55108, SM5118

MC145109, PLL02A, PLL02AG, SM5109, TC9100P

uPD2814C, HD42853, KM5624, uPD2824C

Manufacturers I.D. for prefix's:

HD - Hitachi

LC - Sanyo

M - Mitsubishi

MB - Fujitsu

MC - Motorola

MM - National Semiconductor

MN - Panasonic

MSM - OKI Semiconductor

NIS - Seiko

TC - Toshiba

uPD - Nippon Elec. Corp.

...any additional contributions would be appreciated..
T.U.

PACE 8010/8015 (MM55107 - PLL)

.... OR

How I made a quick \$402 "PROFIT" off SECRET C.B.
by: P.R.

Had a customer requiring 4-AM units with "Lower" frequencies in the 26.7--MHz range. Conditions of sale were: all identical units, No extra switches, P.A. functional, and 2 year warranty-limited! Price not to exceed \$500; excluding antennas, external P.A. horns, and installation.

In one weekend I found 6-PACE 8010's at flea market/yard sales, and after haggling had only \$48 tied up in them. Usual problems: protector diodes, finals, audio chip, mike cables; only real trouble was making brackets for mounting. Repair and clean-up of all 6 units cost me another \$35.

Getting it to go down was a B----! Gave up and contacted "Custom Conversions"....--said I had the right pin, but wasn't isolating it correctly. Obtained skematic/parts locator/PLL logic codes, and other "tips/hints" on unit. (Also permission to write-up for SCB). Pin-10 of PLL is down conversion; was breaking etch in wrong place; is fed under the chip by another line! Had it up and running in 10 minutes flat... I utilized the ANL push-button for conversion.

Remove following wires from ANL ONLY, leave the others-are used as a tie point-not in circuitry: Green-remove-trace to PCB, remove. Yellow (both)-remove-solder/splice together and sleeve. If you want ANL off, solder the Yellow's to Green. Follow diagram below and re-route the new wires to etch side near PLL chip..

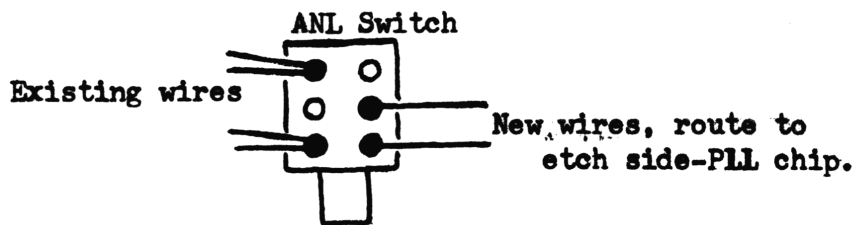

PACE 8010/8015..(Cont.)

Follow diagram below for PLL chip etch modification:

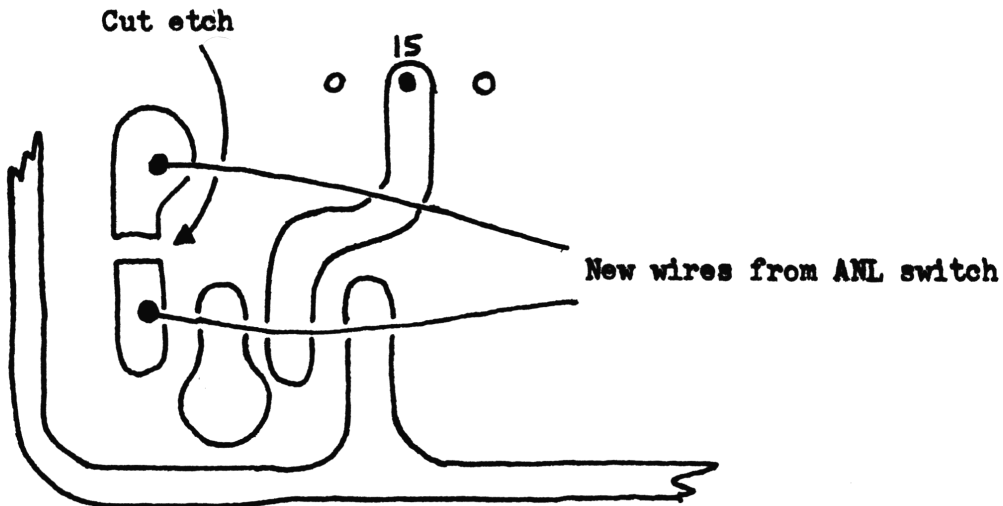

That's all there is to it...actually the fastest and simplest mod., I've ever done! For maximum broadband coverage PLL and RF coils will have to be realigned slightly. Also all the transistor insulators should be changed to 'Mica' type. For 'beefing/mod. increase' the following also: Remove R218, R215A, C216.. Change to 1/2W; R207, R208.. Change C205 to 3.3Mfd/50V.. For better noise limiting change C125 to 3.3Mfd/50V, or higher value, but be careful of audio loss...

Frequency is as follows with the ANL switch in...per selector..

26.695MHz...5	26.845MHz...17
26.705 6	26.855 18
26.715.....7	26.865.....19
26.735 8	26.885 20
26.745.....9	26.895.....21
26.755 10	26.905 22
26.765.....11	26.915.....24
26.785 12	26.925 25
26.795.....13	26.935.....23
26.805 14	26.945 26
26.815.....15	26.955.....27
26.835 16	

I made a quick \$402 profit with 2 spares put up in plastic bags for the warranty - which I doubt will need.

WHO SAY'S SECRET C.B. DOESN'T PAY !!!!!

REALISTIC Pro-54 SCANNER (D.C. Mod.)

Don't convert until warranty period is over, as will void it...

No special test equipment is needed for conversion...

Parts Needed: 10Mfd/35VDC Electrolytic Caps (2-Axial)
Slide Switch: R/S 275-403
Chassis Mount Jack: R/S 274-1549
Standard Power Cord: R/S 270-1533
Fuse: 1/4A 3AG
Diode: 1A, 50 PIV
Solderless Ring, Insulated tongue: R/S 64-3032
Misc. 10" Black stranded 22ga wire
12" Red stranded 22ga wire

Directions: Follow to the letter...

1. Disconnect AC Power Cord from source.
2. Turn ON/OFF switch ON.
3. Remove bottom cover.
4. Remove Red wire on the On/Off switch-clean where removed.
5. Cut the two cable ties and pull Red wire to rear of chassis.
6. Twist the two 10Mfd/35VDC capacitors' leads together, and solder across the speaker terminals. Observe polarity per drawing below:

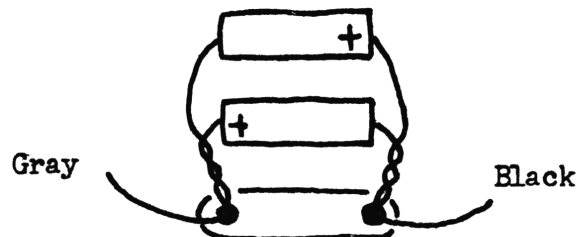

7. Check first to see which of the two chassis jacks fit the power cords' jack (two different sizes in pkg.). Using the one that fits wire up per diagram below-easier to solder wires to diode first:

NOTE: make sure Black wire is a short to outer conductor of the jack...

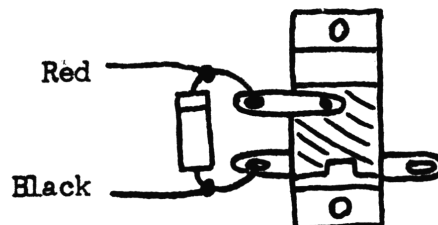

R/S Pro-54 Scanner (Cont.)

8. Mount both slide switch and chassis jack on rear of case per drawing below: DRILL CAREFULLY and use lock washers...

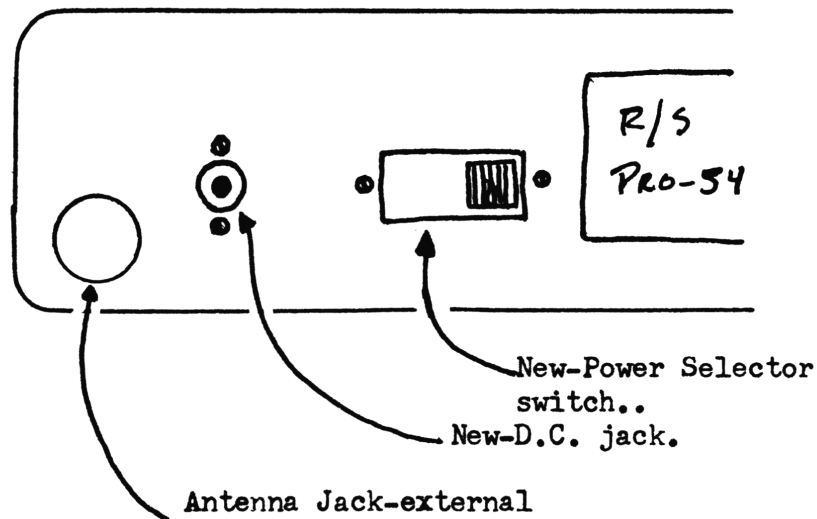

9. Clean all plastic shavings that may have fallen into the unit out carefully. Label back of the unit, above the power selector switch. (D.C.-Left, A.C.-Right)..
10. Finish wiring the selector and power switches per diagram below, -careful with solder-don't get on the P.C. board.

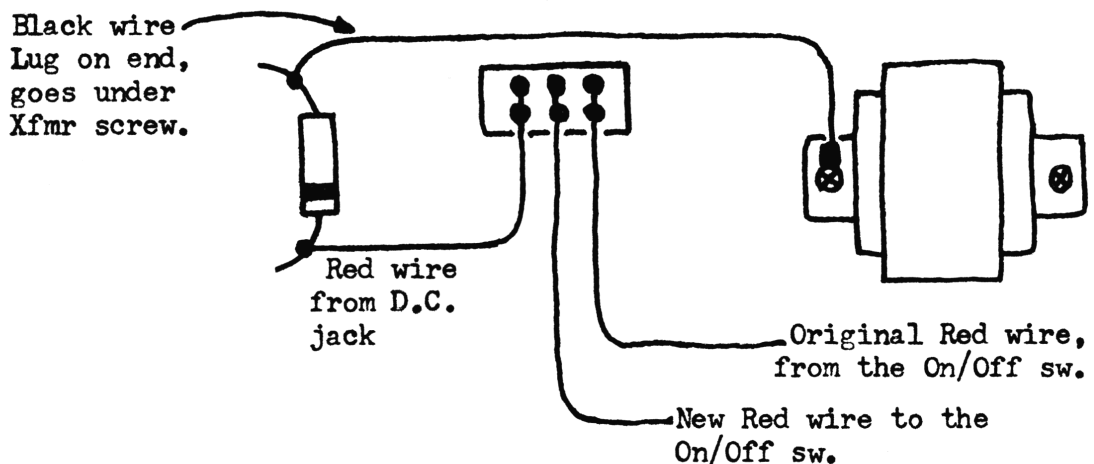

11. Turn On/Off switch off. Check to be sure you put a 1/4 Amp 3AG fuse in the new D.C. cable. Check continuity also from the tip to inside of plug..(some have been wired backwards!)

R/S Pro-54 Scanner (Cont.)

12. Put plug into jack, apply power to jack. (If you don't have a separate power supply, take out to your car and put in the cigarette lighter). Turn on and check all functions...
13. Check function in A.C. also; tie up the cables carefully; put cover back on the unit....Enjoy...

- - FLASH - -
VIDEO "DUBBING/COPYING" TIPS

NOTE: COPYING OF COPYRIGHTED MATERIAL IS STRICTLY ILLEGAL.....

In 98% of all cases can usually 'dub/copy' all video tapes without an "Equalizer/Stabilizer/Enhancer". (Personally haven't found any worthwhile)! There is a "Special Cable" that will do more good than anything found so far - usually can tell difference between original and copy - barely with this cable if taped at same speed. Have seen third copies of original that were excellent by use of it. Will not be found on the Video Dealers shelves, as are in the business of selling "Gadgets", that don't make it.

Using "THE" cable/s and diagram below - follow instructions and you can make quality copies, (have seen 4 movies on 8-hr tape that looked original).

1. Receive machine (Copier) - set recording speed, - IMPORTANT, set "tracking" to middle position and leave alone.
2. Transmit Machine (Original) - use tracking on this unit to adjust for best quality picture (Make a short run of copy to check your quality on playback).
3. Be sure to rewind the tapes on both machines before you start.

VIDEO TIPS (Cont.)

. . Set-up Diagram . .

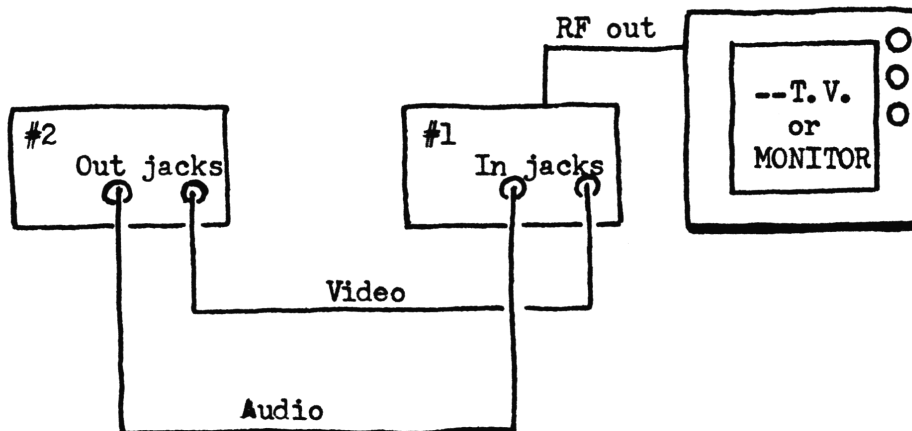

Another note on these cables is: not CHEAP, but worth the cost!
\$9.88 for 6' and \$10.22 for 10' - EACH! Don't bundle up after
buying them; stretch out flat for couple of days; store when not
in use in a wide loop, and in large sealable plastic bag.

Are best investment you could make for use with your VCR....

.....*We can supply these on special order, but do not stock at
present time. If demand is sufficient, will in the future.....

SPECIFIC TUNE-UPS

Sears 934.38060700 (861 PLL)..Use SAMS-236, 934.38062700

Be careful working on this unit - the slugs in TX section have square
holes and very easily broken....

TX - Peak T11, T12, T13, T14, T15

RT-1, Mixer Gain

RT-2, S Meter adjust

RT-3, RF Meter adjust

*There is no AMC adjust; remove D-7; replace with solid buss wire.

If final is blown - don't skimp - replace with 2SC1306!

Midland 1001 (77-001) and Midland 103M (77-103) IC7131-PLL

TX - Peak L205, L-204, L-206, L-207, L-203

RX - L101, L102, L103, L104

RV102 - S Meter adjust. RV103 - Squelch Range adjust

RV202 - RF Meter adjust. RV201 - Modulation adjust (Q106-defeat)

* SELMAN ENTERPRISES

VCR VIDEO MODIFICATION
TRS-80 12" VIDEO DISPLAY (26-1201)

With this display showing up more and more in the neighborhood flea-markets it is a cinch to fix/modify for using to monitor your VCR or any video source, and still retain the computer use of it! It is really a RCA B/W T.V. without the tuner, and usually these can be picked up for spare parts at local T.V. shops by just hauling them away for free! Cheaper for people to buy new B/W T.V. than to have the old one fixed-so parts are no spares-just be sure to get R/S's Factory Service Manual on the unit so can cross reference to RCA, then to SAMS.... CAUTION: To anyone who tries this modification and hasn't any T.V. repair experience; be careful; as you will be working 10KV + in the chassis when turned on, and can still bite-off!

I built mine for \$12.48, including cost of display, using junk-box parts.

PARTS LIST

LED'S: Red-1, Green-1
Disc Capacitors: .1mfd/50V (2), .01mfd/50V (1)
Electrolytic Caps: 1000Mfd/20VDC-1, 250Mfd/35VDC-1
Bridge Rectifier: VM08 or equivalent
Transformer: 117VAC Pri-12VAC Sec. 300ma Min..
Voltage Regulator: LM7805 and heat sink (make out of beer can tab!)
Resistors: 680 ohm and 220 ohm, $\frac{1}{2}$ W 10%
Jack: RCA Female, chassis mount-with ground lug..
Switch: Double Pole-Single Throw, DO NOT TRY SPST...
Mini-RF Coax: 16"
Perfboard: any size you think you can breadboard the P/S mod on is O.K.
Misc. Wire is also needed, along with mounting hardware...

Diagram below is for wiring of the new Video input to Video Isolation Board.

Use the following parts for this and wire it correctly using the other diagrams for locations to mount...

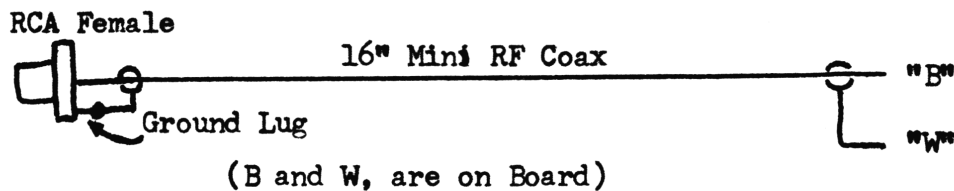

VCR VIDEO MOD. (Cont.)

Follow schematic/diagram below for building/wiring of Power Supply modification..DO NOT CHANGE IN ANY WAY THE WIRING.....

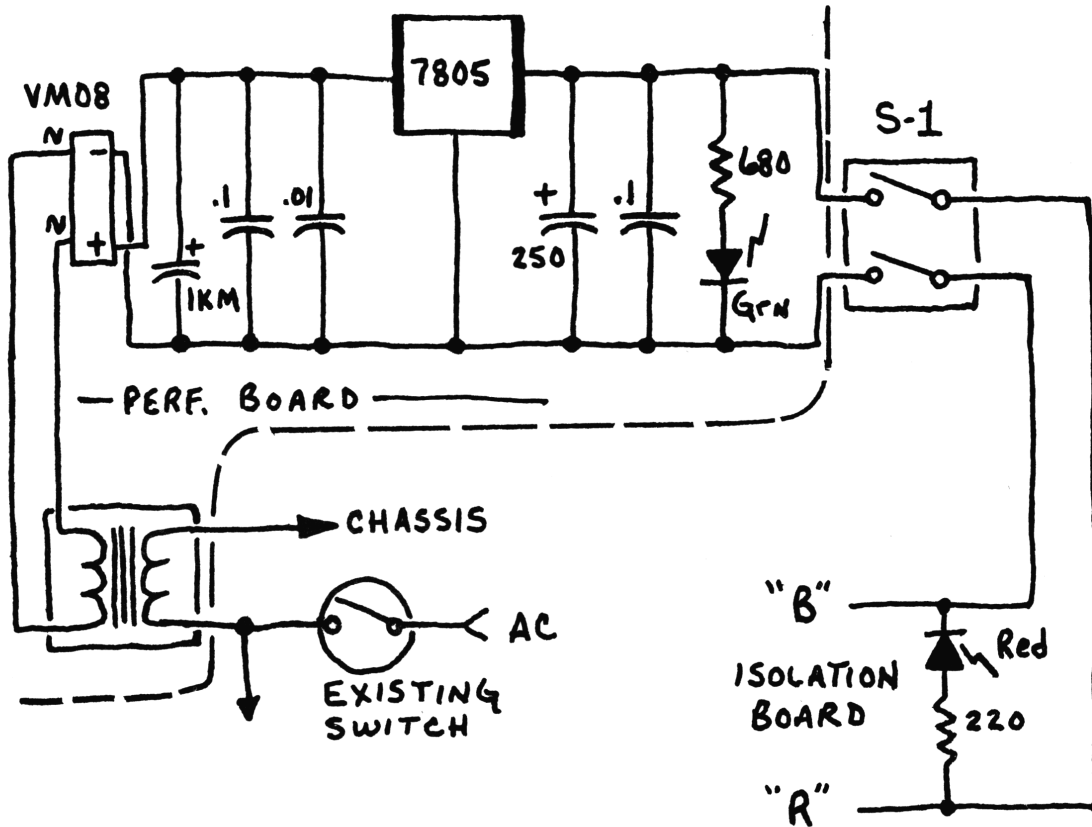

Follow Drawings for front and rear view of component mounting and for drilling holes:

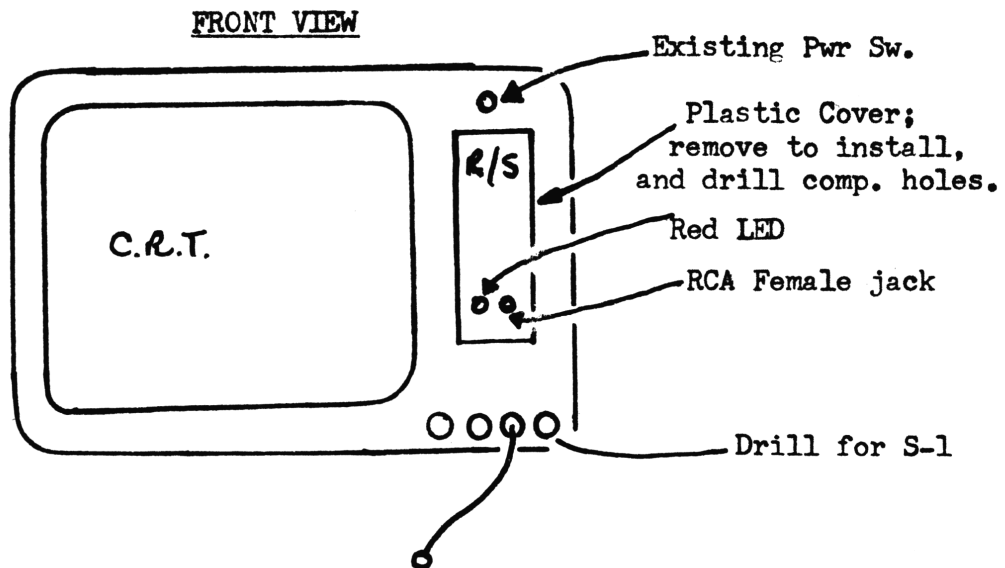

VCR VIDEO MOD. (Cont.)

Note: When drilling hole for Red LED, obtain a rubber grommet to mount the LED in.

REAR VIEW

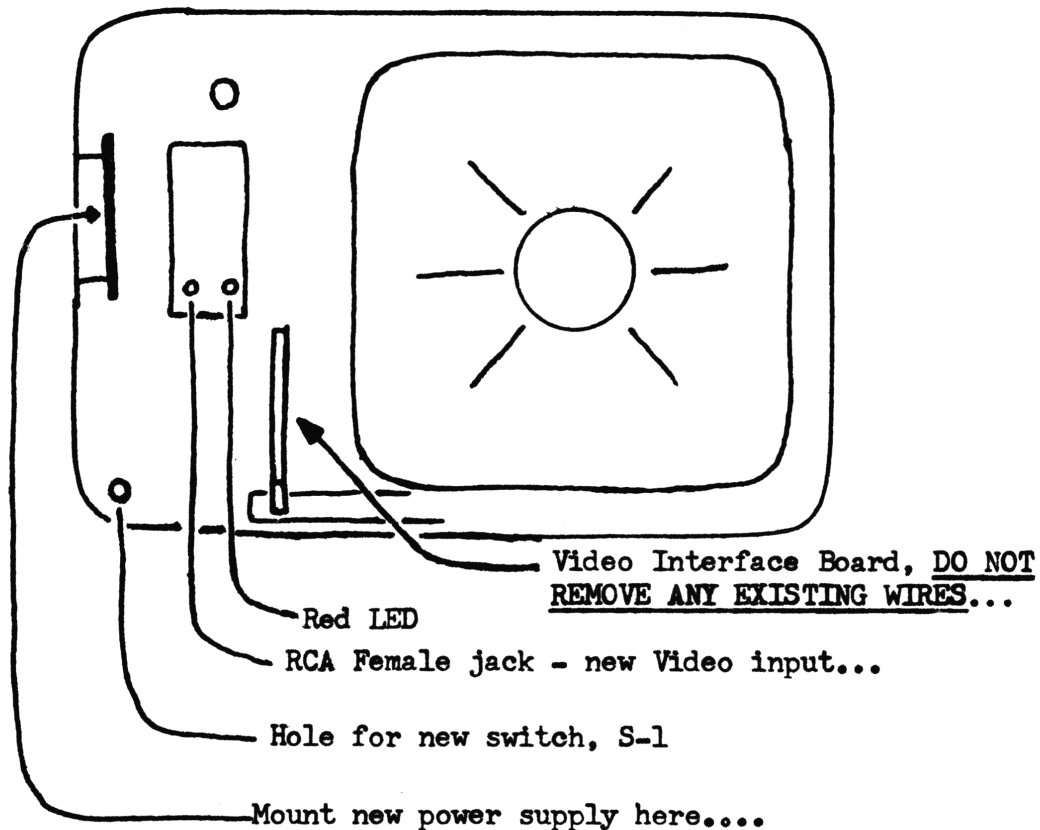

Directions for use:

Under no circumstances should the computer be plugged in when red LED is ON. When light is OFF can be used as usual with the computer, just be sure nothing is plugged into the new video jack.

For use as video monitor - remove plug from computer - Note: if you don't have computer just remove the plug and install new wiring to have an extra video jack for "video mixing" of the input (get some wierd pictures).. Just come out of Video Out jack of VCR to the new RCA jack and you got it...

VCR VIDEO MOD. (Cont.)

VIDEO ISOLATION CARD MODIFICATION

. . . Early to Late Version + . .

Check the card to see if it has a Zener diode above R-5 on the component side. If not, is early version - perform the following:

All resistors 1/2W 5%; Change R-16 to 2.2K

Change R-13 to 6.8K

Remove R-3, replace with 1N4742 Zener
(See diagram below for polarization-12V, 1W)

Add 68K 1/2W 5% as shown in diagram.

* Change R-5 to a 1K variable resistor, may have to enlarge holes a bit..set to mid-position before turning on the power...then adjust for best video on the CRT with an input....

. . . .Component Side of Card. . . .

(* Do on late version if not done....

Correct orientation of Zener.....

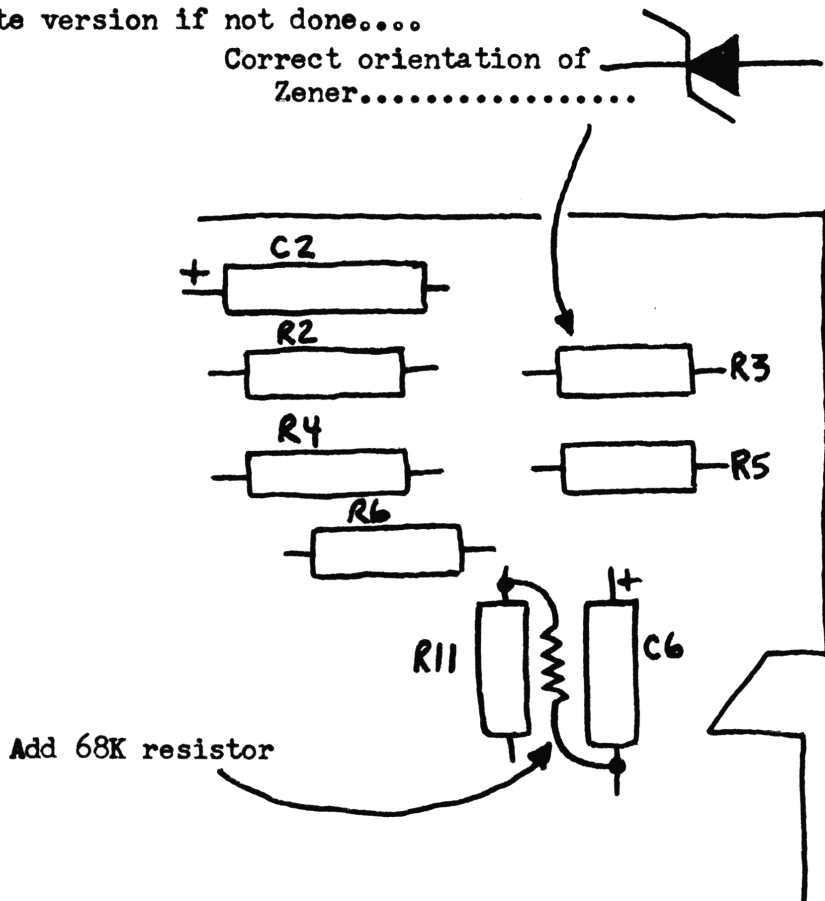

OOP's - We GOOFED!



5 April 85

Vol. 4, Pg. 54: Re; 25.675 to 26.165MHz (Fo chart).
1 to pin 7
0 to pin 8

DELETE: ~~0~~ 0 to pins 10/11

Vol. 16, Pg. 50: Re; 148GTL-DX (EARLY), Change EARLY to LATE in
the title heading, also Pg. 51....

Skematic: Change TR39 to TR36.

Skematic: Change transistor drawing: reverse
arrow drawings on the emitters,
BOTH...

Vol. 15, Pg. 58: Re; TRISTAR 747 - DISREGARD ENTIRE SLIDE MOD!
all wrong....see both corrections printed
in this volume... SCHEMATIC IS A 747.....

Vol. 16, Pg. 72: Re; OOP's Ray Jefferson...Correction should read
Vol. 12, pg. 27; not Vol. 13!

ED NOTE: This is 4th and LAST time to get this
straight in OOP's column ---Standard 02A AM
Mod,---OR throw the D-- thing in the trash!!!

Notes

SECRET CB INDEX

VOLUMES 1 THRU 16

CONVERSIONS:

	<u>VOL/PG</u>
Conversion tips for	
all SSB radios.....	9/7
"A" Channel Mod. for	
all SSB.....	9/16-17
Cybernet Freq. Mod.....	8/18
Uniden 8719PLL Mod.....	8/15
MB8719 Mod.....	10/25-26
MB8719 w/11.1125 Mod.	
.....	11.15, UPDATE.14/11-12
PLL01A Mod.....	9/15-17
PLLO2A Mod..4/54-55,3/13-15	
02A Truth Table.....	15/12-13
23 Ch. PLLO2A AM Conv.	
26.645 to 27.275.....	12/32
Tech tips on the 858	
Chassis.....	10/55
Uniden 858 update....	9/8-11
How to get on 28 & 29 MHz	
w/uPD858 PLL.....	11/4-7
uPD858 AM Conv.....	11/35
Receiver Widebanding	
for 858 Chassis.....	13/34
NEW Thumbwheel Conversion	
for 858 Chassis...13/35-37	
How to increase ANL	
efficiency 70%.....	11/8
Ham Radio Crystal	
Selector.....	12/24

BOMAN

CB910.....	11/41,13/58
CB920.....	14/43
CB930.....	3/21
CB950.....	5/39

BROWNING

Mark III.....	6/28
Mark IV.....	6/29-30
Mark IVA.....	14/5-6
Mark IV, IVA.....	7/8-14
Sabre.....	1/27

CHANNEL MASTER

CB6830.....	14/41
-------------	-------

COBRA

CAM89.....	14/45-46
32XLR.....	4/47
50XLR/55XLR.....	16/53
132B.....	1/53
132XLR.....	4/47
135B.....	1/53
135XLR.....	4/38
135XLR Update.....	10/43-46
138XLR.....	1/20-23
139XLR.....	1/20-23
140GTL.3/19-20,4/50,10/28-29	
142GTL.....	4/50,10/28-29
146GTL.....	11/17-18,15/18-19
148GTL.....	8/16
148GTL-DX.15/20-24,16/50-51	
2000 (C.A.P.).....	6/23
2000GTL.5/20,7/15-17,15/25-28	

COLT

SX33.....	3/4-7
290.....	3/4-7

CONVERSIONS:

	<u>VOL/PG</u>
<u>COLT (cont.)</u>	
390.....	3/4-7
480.....	3/8-15, 5/39
485.....	3/8-15
800.....	3/4-7
1000.....	3/8-15
<u>COURIER</u>	
Centurion PLL....1/31,61-62	
.....	5/57
Centurion 40D.....	10/53
Galaxy.....5/53-54,7/18-22	
Gladiator PLL....1/31,61-62	
.....	5/55-57
Spartan.....	1/61-62
.....	5/30,53,55,57
<u>CPI</u>	
300.....	8/21
400.....	8/21
2000.....	3/25
2000 Low.....	9/23
2500.....	5/37-38
<u>CRAIG</u>	
L131 & L231.....	9/12-14
L132 & L232.....	9/12
L232 & L132 w/uPD2824C	
Chip.....	10/47,11/10
L321.....	14/12

DAK

IX.....	5/21-23
IX Mod. Update.....	9/18-19
X.....	4/39-46

DELCO

Delco Factory AM/FM/CB	
Combo Unit.....	11/38-40
DM83.....	12/26
90BFMC1.....	12/26
90BFPC1.....	12/26
91YFMC1.....	12/26

DEMCO

Star II.....	5/60
Super Satellite.....	5/60

FANON

Fanfare 350.....	5/57
------------------	------

FIELDMASTER

Micro Mini 40.....	11/37
TR-40.....	15/63

GENERAL ELECTRIC

Superbase 3-5875/A....	10/48
3-5801A.....	16/33
3-5813A/3-5869A.....	14/41

GEMTRONICS

GTX77.....	5/39
GTX-2325.....	15/29

HALLICRAFTERS

HCM271.....	5/50-51,6/39
-------------	--------------

HYGAIN

I-A.....	1/22
PLL.....	1/32
II.....	8/20

CONVERSIONS:

	<u>VOL/PG</u>
<u>ITT</u>	
CB-4000M.....	13/61
CB-4400M.....	4/17-18
<u>J. C. PENNEY</u>	
6246.....	13/61
6248.....	8/24

JOHNSON

242-4730.....	10/49-51
4125/4174.....	13/61
4140.....	15/31
4740 (NDC40013).....	11/12

KENWOOD

TS-120S.....	12/22
TS-130.....	12/23
TS-820S.....	14/7-8,15/33-34
TS-530S.....	15/32

KRACO

KCB2330A.....	9/15
KCB4806.....	15/59

LAFAYETTE

55B75.....	14/9
------------	------

LAKE

400.....	16/52
----------	-------

MECTRON

ME502.....	14/41
------------	-------

MIDLAND

CAP 858.....	5/30
13-857.....	11/36
13-862.....	14/48-49
13-882C (02A)....	13/62,15/35
13-883B (uPD858).....	12/4
76-858.....	16/21-24
77-861.....	12/26
78-574.....	14/10
79-892.....	15/36-38
79-893.....	2/20
79-900.....	5/47
6001.....	11/16,16/60-62
7001.....	8/21,11/16,16/60-62

MORSE

3005.....	2/27
-----------	------

MOTOROLA

CB555 (TC9105P).....	12/7
T4025A.....	10/46

NESCO

1249.....	6/38
-----------	------

PACE

166.....	15/42
1000MC/1000BC.....	15/39-41
8010A.....	15/43
8015A.....	15/43
8155.....	15/43
8025.....	15/44
8092.....	6/35-36
8093.....	15/48

PALOMAR

500.....	4/19-20,5/32-36,8/21
.....	15/45

CONVERSIONS:

	<u>VOL/PG</u>
<u>PANASONIC</u>	
RJ3600.....	10/57
RJ3700.....	13/16-17

PEARCE-SIMPSON

Cheetah PLL.....	1/31-32
Simba PLL.....	1/31-32

PRESIDENT

Adams.....	2/16,13/18-20
AR144.....	11/17-18
Grant.....	1/22-23,59
.....	2/17,23-26
Grant (NEW).5/24-27,13/21-22	
Home Ch. Conv.....	14/13-17
Honest Abe.....	1/60
John Q.....	1/60
Madison w/11.3258.....	10/30
McKinley.....	4/12-13
McKinley w/11.1125.....	10/29
Teddy R.....	1/60
Washington.....	1/22-23,59
Washington w/11.1125	
(NEW).....	10/28-29
Zachary T.....	1/60

RAIDER

4060.....	15/46
-----------	-------

RCA

14T302.....	5/11,39
14T302 (PLL 02AG).....	4/36

REALISTIC

TRC-57.....	12/28
TRC-431.....	7/23-24
TRC-448 (REC86345)....	11/19
.....	16/25-30
TRC-450.....	10/31
TRC-451.....	12/10-13
TRC-455 (SM5104)....	12/30
TRC-457.....	10/36
TRC-459.....	10/32-35
TRC-480.....	10/37-38
TRC-490.....	12/14-15

RAY JEFFERSON

CB845 (02A).....	12/27
------------------	-------

ROBYN

GT-440D.....	1/23
SB-505.....	5/41-42
SB-520D.....	2/21-22
SB-540D.....	5/19,36,7/25-28
WV-23.....	1/24-25
WV-110 (SM5104)....	12/31

ROYCE

1-601.....	1/26
1-612.....	5/45-46
1-632.....	11/21
1-632 Update.....	13/23
1-639.....	15/48
1-641.....	11/20
1-642.....	13/24
1-655.....	15/47

SANKYO

SCS-555.....	11/40
--------------	-------

CONVERSIONS:

	<u>VOL/PG</u>
<u>SBE</u>	
Console II.....	15/49
Console IV.....	2/28-35
Console V.....	2/28-37
Console VI.....	8/14
Cortez 21CB.....	14/56-57
Formula D.....	1/49
LCBS-4.....	7/29-33
LCMS-4.....	7/34-37
Sidebander II.....	2/28-35
Sidebander V.....	2/36-37
Sidebander VI.....	8/14
Touch Com.....	1/50-51

SEARS

D63911 w/uPD861C.....	12/26
562-38220700.....	10/56
663-3810 w/2824.....	11/22
934-3677150.....	12/16-17
934-36772600.....	12/16-17
934-38260700.....	6/26-27
934-38260700 Update.....	11/23
934-38270700.....	5/28-29
934-38270700 Update.....	9/20-22

SHARP

CB-5470 HD42851B3.....	11/24
------------------------	-------

SILTRONIX

1011C.....	1/46
1011D.....	1/46

SOMMERKAMP

TS-788DX.....	13/25-30
---------------	----------

SONAR

PS-2340.....	5/31
--------------	------

SPARKOMATIC

CB4020S.....	14/41
--------------	-------

STANDARD HORIZON

29-A.....	5/59,13/63
-----------	------------

STONER

Pro-40.....	4/52-53
-------------	---------

SUPERSCOPE AIRCOMMAND

CB340.....	8/19
CB340 (861 Update).....	9/24

SWAN SIGNET

270.....	5/58
----------	------

TEABERRY

52 Ch. Capability.....	1/43
CAP Mod.....	5/30
Model T.....	4/3-4
Racer T.....	1/58
Ranger T.....	4/1-2,6/24-25
Stalker I.....	1/57,4/5-6,10-11
Stalker IX.....	4/7-9,15/55-57
Stalker IX (FM-Export)15/50-54
Stalker XV.....	4/7-9,10/39
Stalker XX.....	10/40
T Bear.....	4/14-15
T Dispatch.....	4/14-15
Titan T.....	4/14-15

TENNA POWER

10901.....	15/63
------------	-------

CONVERSIONS:

	<u>VOL/PG</u>
<u>TRAM</u>	
D12.....	10/56
D42.....	4/47,5/40
D60.....	1/53
D64.....	13/31
D80.....	10/30
D201.....	1/56,3/22-23,4/48
D201A Update.....	10/54
D300.....	8/11-13
<u>TRISTAR</u>	
747.....	15/58,16/68

TRS CHALLENGER

850/1400.....	4/21-27,32-35
---------------	---------------

VECTOR

770.....	4/56-57
790.....	4/58-59

WARDS

719A w/uPD2824.....	11/10
---------------------	-------

YAESU

101.....	5/58
FT-7B.....	7/38-41
FT-707.....	10/20-24
FT-901.....	6/3-12

SLIDE MODIFICATIONS:

	<u>VOL/PG</u>
<u>BOMAN</u>	
950.....	4/49
<u>BROWNING</u>	
Baron.....	15/15-17
<u>COBRA</u>	
29GTL.....	13/57
132-A.....	1/28
132XLR.....	10/45-46,15/15-17
135-A.....	1/28
135-B.....	1/29
135XLR.....	4/38,8/38,10/45-46
.....	15/15-17
138.....	1/28
138XLR.....	1/23
139.....	1/30
139XLR.....	1/23
140GTL.....	4/50,6/64,10/28
142GTL.....	4/50,6/64
.....	8/35-37,10/28
146GTL.....	10/41,11/17
148GTL.....	8/16
2000GTL.....	12/20,13/40
<u>COLT</u>	
480.....	3/11
485.....	3/11,4/49
1000.....	3/11
<u>COURIER</u>	
Centurion.....	1/61,5/55
Centurion 40D.....	10/53
Galaxy.....	5/53,7/19
Gladiator PLL.....	1/61,5/55
Spartan.....	1/61,5/55
<u>CPI</u>	
2500.....	5/37
<u>CRAIG</u>	
L-131.....	9/12-14
L-132 uPD2824C.....	9/12,10/47
L-231.....	9/12-14,12/3
L-232.....	9/12,10/47,11/10
L-321.....	14/12
<u>DAK</u>	
X.....	4/45
<u>FANON</u>	
Fanfare 350F.....	5/55
<u>GENERAL ELECTRIC</u>	
3-5875A.....	10/48
<u>GEMTRONICS</u>	
GTX-77.....	4/49
<u>HYGAIN</u>	
V.....	11/11
623.....	1/33
674-A.....	4/60
<u>J. C. PENNEY</u>	
Pinto SSB.....	1/44
6248.....	13/14-15
981-6247.....	13/13
<u>JOHNSON</u>	
242-4730.....	10/50
352.....	1/34
4740.....	11/12

SLIDE MODIFICATIONS:

	<u>VOL/PG</u>
<u>LAFAYETTE</u>	
SSB75.....	14/9
<u>MIDLAND</u>	
13-883B.....	12/4
13-892.....	4/48,11/13
13-893.....	4/51
13-898.....	1/36
13-898B.....	1/35
78-574.....	14/10
78-999.....	12/5
79-891.....	12/6
79-892.....	11/14
79-900.....	5/47
6001.....	11/16
7001.....	8/21,11/16
<u>MOTOROLA</u>	
CB-555.....	12/7
<u>N. D. I.</u>	
PC-201 (NDC40013PLL).....	12/8
<u>PACE</u>	
1000.....	1/37-38
DX1023B.....	1/39
8092.....	6/37
8193 (CC13001).....	12/9
<u>PALOMAR</u>	
500.....	4/19,5/32,35
<u>PANASONIC</u>	
RJ-3700.....	13/16-17
<u>PEARCE-SIMPSON</u>	
Bengal.....	1/40
Cheetah.....	1/40
Simba.....	1/40
<u>PRESIDENT</u>	
ARI44.....	10/41
Adams.....	1/16
Adams 858.....	13/18-20
Dwight D.....	15/62
Grant.....	1/59,2/23
Grant (NEW).....	5/24,8/34
Grant MB8719.....	13/21-22
Madison (NEW).....	10/30
McKinley.....	4/12,6/64
McKinley (NEW).....	10/29
Washington.....	1/59
Washington (NEW).....	6/64
.....	8/33-34,10/28
<u>RCA</u>	
14T302.....	4/49
<u>REALISTIC</u>	
TRC-47.....	1/41
TRC-48.....	1/42
TRC-57.....	12/28
TRC-448.....	11/19
TRC-450.....	10/31
TRC-451.....	12/10
TRC-457.....	10/36
TRC-458.....	8/39-40
TRC-459.....	10/34
TRC-480.....	10/38
TRC-490.....	12/14-15

SLIDE MODIFICATIONS:

	<u>VOL/PG</u>
<u>ROBYN</u>	
SB-505.....	5/41
SB-540D.....	5/19
T240D.....	13/63
<u>ROYCE</u>	
1-632.....	5/14, 11/21, 13/23
1-641.....	4/51, 11/20
1-642.....	13/24
<u>SANKYO</u>	
SCS-555.....	11/40
<u>SBE</u>	
Console II.....	1/48
Console IV.....	2/34, 38-40
Console V.....	2/34, 38-40
LCBS-4.....	7/30
LCMS-4.....	7/34
Sidebander II.....	1/47
Sidebander IV.....	2/34, 38-40
Sidebander V.....	2/34, 38-40
<u>SEARS</u>	
23 Ch. SSB.....	1/44
Roadtalker SM5104.....	12/18
663-3810.....	11/22
934-3677150.....	12/17
934-36772600.....	12/17
934-38260700.....	10/52
934-38270700.....	5/28, 9/20
934-38310700.....	5/19, 9/22
<u>SHARP</u>	
CB5470.....	11/24
<u>SILTRONIX</u>	
SSB.....	1/45
<u>STONER</u>	
Pro-40.....	4/52, 53
<u>TEABERRY</u>	
Stalker IX.....	4/7-8
Stalker XV.....	4/7-8, 10/39
Stalker XX.....	10/40
Stalker 101/202.....	4/10
<u>TRAM</u>	
D60.....	1/52
D62.....	10/45-46, 15/15-17
D64.....	13/31
D300.....	12/19
<u>TRS CHALLENGER</u>	
850/1400.....	4/33, 16/55
<u>TRUETONE</u>	
CYJ4837A-87.....	11/14
<u>WARDS</u>	
GEN-719A.....	11/10

SPECIFIC RADIO TUNEUPS:

	<u>VOL/PG</u>
<u>AIR COMMAND</u>	
CB640.....	5/38
<u>ALARON</u>	
B-4075.....	9/30
B-4900.....	9/30
B-5050A.....	9/30
B-5200.....	3/41
<u>AMERICAN MOTORS</u>	
3221847/48/49/50.....	12/34
<u>AUDIOVOX</u>	
MCB750.....	3/41
MCB5000.....	11/42
MDU6000.....	6/18, 15/60
<u>AUTOMATIC</u>	
CBH2265.....	3/41
<u>BETA</u>	
23 Deluxe.....	16/32
<u>BOMAN</u>	
CB555.....	3/44
CB750.....	2/43
CB755.....	14/44
CBH900.....	3/44
CB910.....	1/21, 3/44
CB920.....	1/21, 14/43
CB930.....	1/21, 3/44
CB950.....	3/43
CBH990.....	5/43
CBR9600.....	2/42, 3/41
CBR9940.....	3/44
CBR9950.....	10/58
<u>BRISTOL</u>	
BCB-2271.....	16/41
<u>BROWNING</u>	
SABRE.....	14/42
<u>CHANNEL MASTER</u>	
CB6830.....	16/55
CB6834.....	14/44
CB6835.....	6/18
<u>CHRYSLER</u>	
4048076/8077.....	6/18
<u>CLARION</u>	
DMA066.....	3/45
JC202E.....	3/45
RCJ003.....	3/45
TC203E.....	6/18
<u>COBRA</u>	
CAM89.....	14/45
19.....	7/51
19GTL.....	12/34
21GTL.....	3/41, 58
21XLR.....	1/20
21XLR Update.....	10/58
25GTL.....	3/41, 58
29GTL.....	3/45, 14/42
29LTD.....	13/59
29XLR.....	1/20
32XLR.....	3/58
45XLR.....	12/34
46XLR.....	3/43
47XLR.....	3/45
50XLR.....	3/43

SPECIFIC RADIO TUNEUPS:

	<u>VOL/PG</u>
<u>COBRA (cont.)</u>	
55XLR.....	3/43
66GTL.....	10/58
77X.....	9/30
78X.....	4/49, 6/19, 8/44
85.....	15/61
86XLR.....	3/45
87GTL.....	6/19
89GTL.....	6/18
132XLR.....	3/45, 16/39
135XLR.....	3/45, 4/38, 16/39
138XLR.....	1/20
139.....	1/20
139XLR.....	1/20
140GTL.....	3/20, 58, 4/50
142GTL.....	4/50
146GTL.....	10/41
148GTL.....	6/19
148GTL-B.....	16/55
148GTL-DX.....	16/43-49
1000GTL.....	6/18, 14/42
<u>COLT</u>	
222.....	6/20
290.....	3/4
350.....	14/46
390.....	3/4
480.....	3/8, 58
485.....	3/8, 6/19
800.....	3/4
800 Update.....	10/58
1000.....	3/8, 58
1200.....	9/30-31, 16/55
<u>COMMANDO</u>	
2340.....	1/21
<u>CONVOY</u>	
CON-400.....	3/58
<u>COYOTE</u>	
23.....	16/32
<u>CPI</u>	
CP400.....	10/59
<u>COURIER</u>	
Blazer 40D.....	3/58
Centurion 40D.....	10/53, 13/10
Classic PLL40.....	3/43
Classic PLL40 Update.....	10/59
Galaxy.....	5/53
Nightrider 40DR.....	3/46
Rangler 40D.....	3/58
Redball.....	1/21
Renegade 40.....	3/46
Rouge 40.....	3/43
<u>CRAIG</u>	
L101.....	6/20, 11/42
L102.....	6/20
L131.....	10/59
L132.....	9/12, 10/47
L231 (AM, SSB).....	10/60
L232.....	10/47, 11/10
4102.....	16/32
<u>DAK</u>	
Mark II.....	10/60
Mark V.....	12/34
Mark X.....	4/45

SPECIFIC RADIO TUNEUPS:

	<u>VOL/PG</u>
<u>DELCO</u>	
70BFMC3.....	2/43
80BCB2.....	6/20
90BCB1.....	10/60
90BFMC1.....	12/26
90BFPC1.....	12/26
90BFTC1 (FM, AM, CB).....	10/60
91YFMC1.....	12/26
<u>FANON</u>	
10-40.....	6/20
Fanfare 125F.....	3/43
Fanfare 182F.....	3/41
Fanfare 184DF.....	3/47
Fanfare 185PLL.....	3/46
Fanfare 190DF.....	3/47, 7/51
Fanfare 350F.....	3/47, 13/12
<u>FORMAC</u>	
40.....	10/60
<u>GENERAL ELECTRIC</u>	
3-5800A.....	3/50
3-5804B.....	6/21
3-5804F.....	10/61
3-5804G.....	12/35
3-5805A.....	9/31, 10/61
3-5811B.....	9/31, 10/61
3-5812A.....	10/61
3-5814B.....	6/21
3-5817A.....	7/51
3-5818A.....	2/42
3-5819A.....	11/42
3-5821A.....	9/31
3-5821B.....	3/54
3-5825A.....	9/31-32
3-5830.....	3/42
3-5869A.....	2/42
3-5871A.....	13/60
3-5871B.....	3/46
3-5875A.....	9/32, 10/48
3-5900A.....	12/35
<u>GEMTRONICS</u>	
GTX-23.....	15/61
GT44.....	2/42
GT55.....	3/48
GTX66.....	6/21
GTX77.....	6/21
GTX4040.....	3/48
GTX5000.....	3/42, 13/60
<u>GENERAL MOTORS</u>	
CBD-20U (PLL03A).....	12/36
CBD-203.....	3/48
4120.....	3/46
4145.....	9/32
4175.....	3/46
<u>GREAT</u>	
K605/GT818.....	16/32
<u>HYGAIN</u>	
VIII.....	3/59
674A.....	4/60
V674B.....	1/21
2701.....	2/42
2702.....	3/48
2703.....	3/48
2716.....	12/36

SPECIFIC RADIO TUNEUPS:

	<u>VOL/PG</u>
<u>ITT</u>	
4000M.....	13/61
4400M.....	4/17
<u>J. C. PENNEY</u>	
6246.....	13/61
981-6203.....	15/30
981-6204.....	9/32
981-6225.....	14/47
981-6248.....	13/14-15
981-7461.....	9/32
981-8360.....	10/61
<u>JIL</u>	
615CB.....	11/42
<u>JOHNSON</u>	
123A.....	1/21
4125/4174.....	13/61
Messenger 40.....	12/36
Messenger 50.....	7/51
Messenger 80.....	7/51
Messenger 4120.....	3/47
Messenger 4135.....	3/48
Messenger 4140/4145.....	3/54
Messenger 4170/4175.....	3/47
.....Update.....	11/43
Messenger 4250.....	3/48
Viking 200.....	12/36
Viking 260/270.....	3/49
Viking 4330/4360.....	11/43
Viking 4740.....	11/12
<u>K-40</u>	
K-40.....	15/60
<u>KRACO</u>	
KB4045.....	14/47
KCB-2340.....	2/42
KCB-4000.....	11/43
KCB-4003.....	3/42
KCB-4005.....	9/38,11/43
KCB-4020.....	3/49
KCB-4030.....	8/44
KCB-4088.....	3/50
<u>KRIS</u>	
XL25.....	2/43
<u>LAFAYETTE</u>	
Comstat.....	11/45
Dyna-Com 40.....	11/44
CHB740.....	15/60,16/55
HB640.....	2/43
LM-100 (PLL02A).....	12/36
LM-300.....	12/37
SSB75.....	14/9
SSB140.....	11/44
Telestat 1240.....	5/14
<u>LAKE</u>	
410.....	12/37
450.....	12/37
600.....	12/37
<u>MEDALION</u>	
63-240.....	3/50
<u>MIDLAND</u>	
100M.....	10/67
102M.....	14/42
150M.....	7/52
13-858.....	14/42

SPECIFIC RADIO TUNEUPS:

	<u>VOL/PG</u>
<u>MIDLAND (cont.)</u>	
13-862.....	14/48
13-867.....	13/62
13-879.....	14/50
13-881.....	15/61
13-882C.....	13/62
13-892.....	4/48
13-893.....	4/51
63-445.....	11/45
76-858.....	3/49
76-860.....	14/51
76-863.....	3/50,9/33
77-101B.....	8/44
77-101C.....	12/38
77-821.....	3/42
77-824.....	8/44
77-824B.....	12/38
77-824C.....	12/39
77-838.....	9/33
77-849.....	3/50
77-853.....	16/55
77-856.....	11/45
77-861.....	3/50
77-861B.....	11/45
77-865.....	9/33
77-899.....	9/33
77-963.....	3/42
78-574.....	9/38,12/39,14/10
78-999 (02A).....	12/5
79-891 (02A).....	12/5
79-892.....	3/49
79-893.....	2/20
79-900.....	9/33-34
3001.....	12/37
4001 (77-004).....	7/52
5001.....	12/37
6001.....	11/16
7001.....	11/16
7001 (79-007).....	11/45-46
<u>MOPAR</u>	
4094173.....	3/51
4094176.....	3/51
4094177.....	3/49
4094178.....	3/60
<u>MORSE</u>	
2001.....	12/42
<u>MOTOROLA</u>	
CB555.....	12/7
CF925AX.....	11/46
CC975AX.....	16/40
Mocat 40.....	11/46
T4000A/05A/10A/20A.....	3/50
<u>N. D. I.</u>	
PC-102.....	11/46
PC-200.....	7/52
PC-201.....	12/8
<u>PACE</u>	
CB144.....	14/42
CB166.....	15/60
8003.....	11/47
8008.....	2/43
8016.....	11/47
8046.....	9/33
8113.....	12/39
8117.....	11/47
8155.....	9/34,12/40
8193.....	7/52

SPECIFIC RADIO TUNEUPS:

	<u>VOL/PG</u>
<u>PACIFIC</u>	
SSB800.....	16/55
<u>PALOMAR</u>	
49.....	3/60
500.....	4/19,5/32
4100.....	3/54
<u>PANASONIC</u>	
CR-B474EU (AM,FM,CB).....	9/34
RJ-3200.....	14/42
RJ-3250.....	11/47
RJ-3600.....	11/48
RJ-3660.....	14/52
RJ-3700.....	13/17
<u>PEARCE-SIMPSON</u>	
Cougar 23.....	14/53
Leopard B.....	3/49
Puma 23B.....	13/62
Supertiger 40A.....	3/60
Tiger 40A.....	9/34
<u>PIONEER</u>	
GT-100G (AM,FM,CB).....	10/62
<u>PRESIDENT</u>	
AR-7.....	12/40
AR-44.....	10/63
AR-144.....	10/41
AR-711.....	12/34
AX-7.....	12/45
AX-11.....	12/45
AX-14.....	12/45
AX-44.....	12/45
AX-52.....	12/45
AX-55.....	12/45
AX-144.....	12/45
AX-711.....	12/40,45
Adams.....	2/16
Andrew J.....	9/34
Dwight D.....	10/62,14/54
Grant.....	1/22
Grant (NEW).....	5/24
James K.....	7/52
James K (NEW).....	12/40
McKinley.....	4/12
Old Hickory.....	9/34
Washington.....	1/22
Zachery T.....	14/54
<u>RAY JEFFERSON</u>	
CB-845.....	11/48
<u>RCA</u>	
14T270.....	9/36
14T300.....	2/43
14T302.....	3/53
14T303.....	11/48
<u>REALISTIC</u>	
TRC-45A.....	4/37
TRC-47.....	1/21
TRC-57.....	1/21,12/28
TRC-99A.....	4/37
TRC-100.....	4/37
TRC-180.....	4/37
TRC-200.....	4/37
TRC-200 Update.....	10/63
TRC-204.....	10/63
TRC-205.....	12/40
TRC-206.....	14/55
TRC-209.....	10/63

SPECIFIC RADIO TUNEUPS:

	<u>VOL/PG</u>
<u>REALISTIC (cont.)</u>	
TRC-209 (GRE7189PLL-VC).....	12/49
TRC-210.....	16/32
TRC-410.....	12/29
TRC-411.....	15/60
TRC-420.....	12/41
TRC-421.....	8/44,12/41
TRC-421A.....	9/35
TRC-422.....	8/45
TRC-422A.....	10/64,67
TRC-424.....	3/57,9/35
TRC-425.....	7/53,10/67
TRC-426.....	10/64
TRC-427.....	8/45
TRC-428.....	11/48
TRC-431.....	4/37
TRC-432.....	11/48
TRC-440.....	8/45,9/35
TRC-441.....	10/67,11/49
TRC-448.....	3/51,10/64,11/19
TRC-449.....	3/51,9/35-36
TRC-451.....	12/10
TRC-452.....	1/21,3/52
TRC-454.....	8/45
TRC-455.....	3/60
TRC-456.....	10/67
TRC-457.....	9/35-36,10/36
TRC-458.....	9/35
TRC-459.....	10/34
TRC-461.....	3/51
TRC-462.....	9/36
TRC-466.....	3/51
TRC-468.....	3/57
TRC-470.....	9/39,12/41,16/40
TRC-471.....	8/45
TRC-480.....	7/53,10/37
TRC-490.....	11/49,12/15
<u>REGENCY</u>	
CR240.....	16/32
<u>ROADRUNNER</u>	
CB5000A.....	16/41
<u>ROBERTS</u>	
40 CH.....	14/42
<u>ROBYN</u>	
007-140.....	3/52
AM500D.....	3/52
DG130D.....	3/56
GT-410D.....	3/57
LB120.....	3/52
SB-505.....	5/42
SB-520D.....	2/22
SX-401.....	3/57
SX-402D.....	3/57
T240D.....	3/56,13/60,63
WV110.....	3/56
WV110 Update.....	11/50
<u>ROYCE</u>	
1-580.....	16/32
582 (PLL3001).....	12/42
604.....	3/56-57
607.....	12/42
611.....	14/55
1-617.....	3/52
1-619.....	3/56
1-621.....	3/57
1-625.....	3/56
1-632.....	11/21
1-639.....	12/41

MISCELLANEOUS LISTED BY VOLUME

SPECIFIC RADIO TUNEUPS:

	VOL/PG
<u>ROYCE (cont.)</u>	
1-641.....	3/60,4/51,11/20
1-642.....	13/24
1-650.....	14/42
1-651.....	7/55
1-655.....	11/50
1-660.....	2/42
1-673.....	3/52
1-675.....	3/53
1-680.....	3/52

SBE

Console V.....	15/61
21-CB Cortez.....	14/56
26CB1A.....	3/61
42CB Cortez 40.....	3/61
43CB.....	3/53
44CB.....	9/36
45CB Trinidad III.....	3/61
47CB.....	3/53
49CB Tahoe 40.....	3/53
LCB-8 (uPD2826C).....	12/43
LCBS-4.....	7/32
LCM-5 Land Command.....	9/36
LCM-8.....	9/36
LCM-8 (PLL03A).....	12/42
LCMS-4.....	7/35
LCMS-8 (uPD2816C).....	12/43

SEARS

CM-6000LA.....	3/59
CM-6000LC.....	3/59
Roadtalker 40.....	2/43
370-38050700.....	3/54
562-38200700.....	3/55
663-38020800.....	7/53
663-38070700.....	3/61
663-3810.....	11/22
663-381050.....	11/21
934-3677150.....	12/16
934-36772600.....	12/16
934-38061700.....	11/50
934-38062700.....	10/65
934-38080700.....	9/37
934-38081700.....	9/38
934-38120700.....	3/61
934-38260700.....	7/53
934-38270700.....	7/54
934-38310700.....	7/54-55

SHAKESPEARE

GBS240.....	3/53
-------------	------

SHARP

CB-23.....	13/63
CB-800.....	2/42
CB-2170.....	12/43
CB-4370.....	12/43
CB-4470.....	12/44
CB-4670.....	7/55
CB-5470.....	11/24

SONAR

FS-2340.....	5/31
--------------	------

SPARKOMATIC

SR-42/CBM.....	3/54
----------------	------

STANDARD

29.....	1/22
29A(uPD857).....	13/63

SPECIFIC RADIO TUNEUPS:

	VOL/PG
<u>SUPERSCOPE</u>	
Aircommand CB1040.....	14/57

SURVEYOR

620.....	3/55
2610.....	3/54

TEABERRY

Big T.....	15/61
Model T.....	3/55
Racer T.....	3/55
Titan T.....	15/61
Stalker II.....	1/21
Stalker III.....	7/55
Stalker IV.....	12/44
Stalker V.....	7/55
Stalker VIII.....	10/65
Stalker IX.....	10/65
Stalker XII.....	7/56
Stalker XV.....	10/39
Stalker XX.....	10/40
T Charlie.....	10/65
T Command.....	3/55
T Dispatch.....	3/55

TENNA

10901.....	10/58
10902.....	10/65
11302 (AM,FM,CB).....	9/37

TRS

Challenger 432.....	4/23
Challenger 460.....	14/59
Challenger 600.....	9/37
Challenger 850.....	4/32,7/55
Challenger 1200.....	12/44

TRAM

D12.....	3/54
D64.....	13/31
XL-5.....	16/32

TRUETONE

CYJ4832-A-87.....	2/43
CYJ4837-A-87.....	3/59
CYJ4862-A-87.....	9/39
MCC4434A-57.....	14/60
MCC4726A-67.....	15/61

UTAC

TRX-400.....	3/59
TRX-500.....	5/56

VECTOR

X.....	2/43
770.....	9/37
790.....	9/37

WARDS

GEN-680A.....	14/61
GEN-696A.....	14/61
GEN-719A.....	11/10
GEN-775A.....	3/61

XTAL

XSSB10.....	1/22
-------------	------

VOLUME 1

	PAGE #
GOLDEN EAGLE MARK IV PING MODIFICATION.....	20
CRYSTAL CROSS REFERENCE GUIDE.....	5-10
LETTER CHART FOR CRYSTAL FREQ. CORRELATION.....	11-18
GENERAL INFORMATION.....	63-67
LINEARS.....	68-70

VOLUME 2

	PAGE #
NEW CRYSTAL CROSS REFERENCE GUIDE.....	5-9
LETTER CHART FOR CRYSTAL FREQ. CORRELATION.....	10-13
PRESIDENT GRANT RF GAIN & ADJACENT CH. REJ. MOD.....	18-19
ROBYN 510D/520D NOISE BLANKER ALIGNMENT.....	25-26
COBRA 139XLR SERVICE BULLETIN ON CRYSTAL DRIFT PROBLEM & PCB CRACKING.....	45-50
SERVICE BULLETIN ON SIDEBANDER II & CONSOLE II FOR IMPROVING CROSS MODULATION REJECTION.....	51
SERVICE BULLETIN-COBRA 29 ON MODULATION IMPROVEMENT, ALSO NOISE BLANKER.....	52
ANTENNA REPORTS.....	53-55
BETA-COM INFO (UPGRADING 23 CHANNEL RADIOS).....	57-87

VOLUME 3

	PAGE #
PRESIDENT MADISON FREQ. COUNTER MOD.....	16-18
NOISE WHINE CURE.....	24
MICROPHONE WIRING INSTRUCTIONS.....	26-32
PLL CHANNELIZER.....	33-40
ANTENNA SECRETS (K40 STUD MOUNT FOR BIG STICK).....	63-64
SPECIAL SECTION ON LINEAR AMPLIFIERS:	
50-70W MOBILE.....	66
300-400W BASE.....	67-69
70W BASE.....	70-71
EAGLE 200.....	72
EAGLE 500.....	73
CONVERSION FROM AMATEUR TRANSMITTER TO LINEAR AMP...	74
LINEAR AMP PROBLEMS & SOLUTIONS.....	75-76

VOLUME 4

	PAGE #
HOW TO BUILD YOUR OWN RELAY MODULE.....	16
02A CHIP INFORMATION.....	54-55
HINTS & KINKS ON COBRA 62XLR & 142GTL.....	61
TURNER MIC EXPANDER (500AMC DISABLE).....	62
K40 BLINKIE.....	63
SUNSPOT PREDICTION CHART.....	64
LINEAR REPORT SECTION:	
D & A MAVERICK.....	65
D & A 500 TRIPLE CONVERSION.....	65
EAGLE 515 MODIFICATION.....	66-67
UNIDEN SSB 10METER POWER CONVERSION.....	68-70
SUPER CLARIFIER DIODE.....	71

VOLUME 5

	PAGE #
10 METER CONV. MICROCOMPUTER (MICROMONITOR PLL).....	1-5
ECHO BOX.....	6
250 WATT DUMMY LOAD - "SECRET CB'S LITTLE DUMMY".....	7
BUILT IN POWER MIKE.....	8-9
5-MILE SIMULATOR.....	10
RECEIVER PRE-AMP.....	11
GLEN DIGITAL CONTROLLER.....	12-13
GETTING SWR DOWN ON BASE ANTENNAS.....	15
APARTMENT ANTENNA.....	16
GROUNDING MOBILE RADIOS.....	17
OOPS! WE GOOFED!	
VOL. 1, PAGE 23.....	18
VOL. 2, PAGE 20 & 21.....	18
VOL. 3, PAGE 4, 7, 11, 25, 33.....	18
VOL. 4, PAGE 5, 45, 50.....	17

VOLUME 5 (cont.)

DAK MARK IX POWER MODIFICATION..... 21-23
SUPER POWER MODULATION MOD. FOR BOWMAN BASE CBH990.. 43
THE ART OF WIDEBANDING 858 CHIP..... 44
CONVERSION KIT + MARS & CAP FOR SSB..... 48-49
CONVERSION OF AM/SSB TO 10 METER AMATEUR..... 52
REDCO UFO INSTALLATIONS..... 61-69
HINTS & KINKS - COBRA 140/142/148GTL REGUALTOR
IC SHORTING OUT..... 70
SLIDE INCREASE, ALL SSB RADIOS..... 71
RADAR COMMUNICATOR..... 72-73

VOLUME 6

PLL CRYSTAL CROSS REFERENCE GUIDE..... 1-2
SECRET CB TEST TONE..... 13
ERRONEOUS SIGNAL LOCATOR..... 14
LOW COST AMATEUR CONVERSION FOR 10 METERS..... 15
BASE ANTENNA GROUNDING..... 16-17
SUPER CLARIFIER 10-TURN POT..... 22
OOPS! WE GOOFED!
VOL. 5, PAGE 19, 20, 28..... 25
THUMBWHEEL 200 CHANNEL CONVERSION FOR 858 CHASSIS.. 31-34
REDCO UFO APPLICATIONS..... 40-52
SPECIAL SECTION ON LINEAR AMPLIFIERS:
PDX 400..... 54
D & A MAVERICK 250..... 55
MACO DUSTER 300, 750 & 1000 TRANSMITTER..... 56-57
MACO 75..... 58
500 CX & 700 CX 10 to 11 METER CONVERSIONS..... 58
RDX-75..... 59
HDX-50..... 59
MDX-200..... 60
PDX-400..... 61
10 METER EXPERIMENTER BOARD INFORMATION..... 62-63
HOW TO MAKE CYBERNET CHASSIS SLIDE..... 65
HOW TO HOOK UP GLEN 310 TO PRESIDENT WASHINGTON.... 67
SUPER CLARIFIER HINTS..... 66
REDCO DX-50..... 68-70

VOLUME 7

HOW TO MAKE YOUR EAGLE SCREAM..... 14
IMPROVED SLIDE MODIFICATION FOR 02A SSB RADIOS..... 42
UPDATED 200 CHANNEL AMATEUR CONVERSION FOR 858 CHIP 43-48
10 METER CONVERSION FOR SSB RADIOS USING MB8719.... 49-50
HOW TO MAKE YOUR 858 CHASSIS SLIDE..... 56
LINEAR AMPLIFIER NOTES..... 57
RECEIVE AMP - SILTRONIX..... 58-59
ECHO BOX SPEECH PROCESSING FOR TRC-449..... 60
ADDING PING..... 61
CORRECTION TO THUMBWHEEL 200 CHANNEL CONVERSION... 62-63
MICROMONITOR TECH NOTES..... 64-69
MICROMONITOR INSTALLATION for RADIOS USING 858.... 70-71
AMP FOR RF PROBE..... 72
OSCILLOSCOPE MOD. FOR RF & MODULATION DISPLAY.... 73
THE "BANDIT" ANTENNA..... 74-76
SECRET CB'S OWN "TROUBLESHOOTER"..... 77

VOLUME 8

WHAT'S NEW ON THE ELECTRONICS HORIZON?..... 1-6
UHF FM CB (GMRS)..... 7-10
UNIDEN MB8719 PLL CHIP FREQUENCY CONVERSION..... 15
FREQUENCY MOD. FOR J.C. PENNEY, COLT, LAFAYETTE,
HYGAIN, ETC..... 18
BROWNING MARK IVA MOD. & UFO INSTALLATION..... 22-23
BROWNING MARK IV TRANSMITTER TROUBLESHOOTING.... 25-32
OOPS! WE GOOFED!
VOL. 5, PAGES 31, 32, 33, 34..... 41
VOL. 7, PAGES 31, 37..... 42-43

VOLUME 8 (cont.)

LINEAR AMPLIFIER NOTES:
INSTALLING & TROUBLESHOOTING LINEAR AMPS..... 47-49
10 METER AMP BOARD MOD. TO UPRIGHT DRIVER..... 50
YOU CAN BUILD IT:
TWO-TONE GENERATOR..... 51
YAESU 601 (B) FREQ. COUNTER MOD. TO READ
CB LOW, MIDDLE, HIGH FREQ..... 52-54
RF TEST METER..... 56-57
REDCO UFO MODIFICATION (FROM 20 to 29.995 MHz).... 55
SECRET CB'S POWER VECTORING..... 58
HOW THE ECHO BOX CAN ACTUALLY SURPASS THE POWER
OF A LINEAR IN SSB..... 59
MICROMONITOR QUESTIONS..... 60-62
MICROMONITOR INSTALLATION INSTRUCTIONS:
SM5104 PLL..... 63-64
ICOM 22S..... 65-67
NEW PRODUCT RELEASE:
ZAPPER 9000 MOD. & REFERENCE CHART..... 68-69
REDCO DIGI-SCAN UFO ELITE..... 70
CHOPPER CHARLIE ANTENNA, MODEL 64#5..... 71
TROUBLESHOOTER..... 73
AMATEUR VSB-1 (VOICE SIGNAL BOOSTER)..... 82

VOLUME 9

SSB'ER LOSE OUT AGAIN..... 1
FCC ANNOUNCES PLANS FOR SIDEBAND..... 2-3
FCC DELAYS NPRM: SSB FREQS. DOUBTFUL..... 3-4
SPEED-O-MATIC "SPEEDO-1" X-BAND RADAR GUN..... 5-6
CONVERSION TIPS FOR ALL SSB RADIOS..... 7
RELAY CRYSTAL SWITCHING..... 25-26
LETTER FROM A FRIEND..... 27-28
HINTS & KINKS-ELECTRONIC CRYSTAL SWITCHING..... 29
OOPS! WE GOOFED! VOL. 8, PAGE 17..... 29
SOLVING T.V.I..... 40-42
RADACRUZ..... 42
IMPORTANT FACTS ABOUT ECHO BOXES..... 43-44
OOPS! WE GOOFED! VOL. 4, PAGE 51..... 44
VOICE SIGNAL BOOSTER (VSB-1) INSTALLATION..... 45-48
POWER SUPPLY MODIFICATION FOR REALISTIC PRE-AMP
NOISE-CANCELLING MIKE #21-1175..... 49-50
HINTS & KINKS - SWITCHABLE MODULATION INCREASE.... 51
RF ATTENUATOR..... 52-54
PRESIDENT SERVICE BULLETINS..... 55-61
INDEX VOLUMES 1 THRU 8..... 62-70

VOLUME 10

SECRET CB TROUBLESHOOTER..... 2-4
VOICE SIGNAL BOOSTER - VSB-1..... 5-19
REPLACING MB8734 with MB8719..... 35
uPD2816C PLL PIN OUT..... 42
TECH TIPS ON 858..... 55
UNCONVERTIBLE CHIP LIST..... 66
LINEAR SUGGESTIONS..... 68-69
ZAPPER 9000 INSTALLATION HINTS..... 70
OOPS! WE GOOFED!
VOL. 3, PAGE 33..... 71
VOL. 5, PAGE 24, 28, 48..... 72
VOL. 8, PAGE 16, 17..... 72-73
VOL. 9, PAGE 9, 51..... 74-75
VOL. 9, PAGE 29..... 72
CB PARABOLIC TYPE ANTENNA..... 77

VOLUME 11

CPI ALC MODIFICATION FOR INCREASED SSB POWER..... 9
HOW TO ADD RF GAIN CONTROL TO A CPI 300/400..... 11
VSB-1 UPDATE..... 25-26
NEW FRONTIER: FM CB..... 27-29
NEW PRODUCT: DIGI-SCAN DS-400..... 30-31

VOLUME 11 (cont.)

	PAGE #
COMING ATTRACTIONS - SERIAL DATA/PLL	
FREQUENCY SYNTHESIZERS.....	32
UNCONVERTIBLE AT THIS TIME -GE 3-5900A TC9101P....	33
ADD CH. 9 & 19AT TO COLT 210.....	33
ZAPPER 9000 INSTALLATION UPDATES.....	34
RADIO MODULATION ADJUSTMENTS FOR VARIOUS MODELS... 51-53	
HINTS ON SERVICING.....	54
SERVICE NOTES-GOLDEN EAGLE MARK IV TRANSMITTER....	55
D104 & D104M6 ASTATIC MIKE MODIFICATION.....	55
HOW TO SOLVE NOISE PROBLEMS.....	56-57
MORE ON THE "TROUBLESHOOTER".....	57
NOISE IN DIESEL TRUCKS.....	58
IN HOUSE VALUE LISTING.....	59
TRUCKERS SPECIAL POLARITY PROTECTOR WITH SMARTS...	60
HOW TO BUILD:	
LOW PASS FILTER.....	61
20db ATTENUATION PAD.....	61
BALUN COIL.....	62
1000Hz TONE.....	63
ADD A SECOND BATTERY.....	64
20 AMP POWER SUPPLY.....	65
SIGNAL INJECTOR.....	66
CMOS LOGIC PROBE.....	67
REFERENCE OSC-DIVIDER.....	68
READOUT MODIFICATION.....	69
ASTATIC MIC MOD.....	70
BILATERAL SWITCH.....	71
PLL PINOUT DIAGRAMS.....	72-77
THE "BANDIT" ANTENNA.....	53
OOPS! WE GOOFED!	
VOL. 3, PAGE 25.....	78
VOL. 6, PAGE 32.....	78
VOL. 7, PAGE 43, 53, 63.....	78
VOL. 8, PAGE 52.....	78
VOL. 10, PAGE 2.....	78

VOLUME 12

	PAGE #
SIMPLE CURE FOR RX-TX TRACKING PROBLEMS.....	21
HAM RADIO CRYSTAL SELECTOR GUIDE.....	24
VS-1 HOOK-UP:	
TEABERRY STALKER XX.....	25
REALISTIC TRC-490.....	25
WARDS GEN-719A.....	25
MODULATION ADJUSTMENTS FOR VARIOUS REALISTICS.....	33
ZAPPER 9000 REDERENANCE CHART.....	46
ZAPPER TROUBLESHOOTING HINTS.....	47-48
TC9106 PLL OPERATION ANALYSIS.....	50-53
THE "SPREAD EAGLE" ANTENNA BREAK-THRU FOR TRUCKERS. 54-55	
BASIC PLL.....	56
ELECTRONIC TERMINOLOGY.....	57
SCANNER PROGRAMMING TIPS.....	58
INTO THE KNOW WITH JAPANESE SEMICONDUCTORS.....	59
TRANSISTOR SPECIFICATIONS.....	60
RESISTOR COLOR GUIDE.....	61-62
CAPACITOR CODES.....	62
YOU CAN BUILD IT:	
"SECRET CB's" SUPER-DUPER POWER	
SUPPLY CONTROLLER.....	63
AUDIO TEST STATION.....	64
POWER LINE FILTER - T.V.I. FILTER.....	65
OOPS! WE GOOFED!	
VOL. 4, PAGE 38.....	66
VOL. 10, PAGE 10, 16, 28.....	66
VOL. 11, PAGE 3, 10, 15, 16, 71.....	66
INDEX VOLUMES 1 THRU 11.....	67-78

VOLUME 13

	PAGE #
INTRODUCING THE SOMMERKAMP TS-788DX.....	4-9
MB8719 PINOUT.....	32
AGC SELECTOR SWITCH.....	38
CYBERNET 02A CHASSIS.....	39
HOW TO HOOK UP A 10 TURN POT TO 2000 GTL.....	40
2824C OPERATION ANALYSIS.....	41-43
VS-1 HOOK-UP: TRC-448 & MIDLAND 77-0004 4001....	43-44
TROUBLESHOOTING CLARIFIER PROBLEMS ON THE 858....	45-47
SUPER REGULATOR.....	48
BUILD A RECEIVER PREAMP.....	49
LINEAR NOTES.....	50-51
MODULATED GUNN OSCILLATER.....	52-56
CYBERNET 02A AM POWER INCREASE.....	59
REALISTIC DX300 (20-204).....	64
BEARCAT 250.....	65
OOPS! WE GOOFED!	
VOL. 4, PAGE 39.....	66
VOL. 6, PAGE 3 & 12.....	66
VOL. 7, PAGE 54.....	66
VOL. 10, PAGE 25 & 48.....	66-67
VOL. 11, PAGE 4, 6, 10, 41, 75.....	67
INDEX VOLUMES 1 THRU 12.....	68-80

VOLUME 14

	PAGE #
MB8719/11.3258 TRUTH TABLE.....	15-17
NEW PRODUCT: FM-30B THRU-LINE FREQ. COUNTER.....	18-19
NEW! "KIT A" FOR LC7130/7131 & TC9106P	
CHIPS & INSTALLATION ISNTRUCTIONS.....	20-40
BROWNING PING INFORMATION.....	41
25-29 MHz FREQUENCY ASSIGNMENTS.....	62-63
ELECTRONIC TERMINOLOGY.....	63
YOU CAN BUILD IT!	
FET RECEIVER PRE-AMP.....	64
BUILD YOUR OWN SPACE SOUND.....	65
BUILD AN AMPLIFIER.....	66-67
INDEX FOR VOLUMES 1 THRU 13.....	68-80

VOLUME 15

	PAGE #
NEW MICROSCAN PLUS SYSTEM.....	5-6
BREAKING THAT CHIP.....	7-11
02A TRUTH TABLE.....	12-13
MEASURE FREQUENCY ON SCOPE.....	17
PM77 POWER MODULATOR KIT.....	19
DIGITAL PROCESSOR KIT/uPD2824.....	28
WIRE GAUGE CONVERSION CHART.....	41
02A 23 CHANNEL AM MOD.....	59
POWER MOD. FOR AM UNITS.....	65
PRE-CONVERSION TIPS.....	70
CONVERT A SALVAGED METER TO VOLT METER.....	71
STATE/INTERNATIONAL DISIGNATORS.....	72
OOPS! WE GOOFED!	
VOL. 12, PAGE 7.....	69
VOL. 13, PAGE 63.....	69
VOL. 14, PAGE 12.....	69
INDEX FOR VOLUMES 1 THRU 14.....	73-79

VOLUME 16

VSB-1 (COBRA 2000) UPDATE.....	6
SAMS CB MANUAL - OUT OF PRINT.....	7
CALL SIGNS/FREQUENCY CHARTS.....	9-20
HINTS/KINKS/GOOFS.....	31
M58472P PLL CHIP MOD.....	33
OSCILLATOR CHECKER, LOW CAPACITY PROBE.....	34
TROUBLESHOOTER GUIDE.....	35-36
INTO THE KNOW WITH POTS.....	37
"MY WAY" SLIDE.....	38
BLEED-OVER FILTER.....	40
LOOP FILTER - WHAT IS IT?.....	42
COLOR CODE GUIDE FOR CHOKES.....	42
ANTENNA INFORMATION.....	56
O2A CLARIFIER/BANDSWITCH MOD.....	57-59
HIGH CURRENT METER.....	63-64
SWR VS REFLECTED POWER CHART.....	65
CUSTOM FREQUENCY STANDARD.....	66-67
CHECKING MODULATION.....	69
DIGITAL PROCESSOR KIT (#146) UPDATE.....	70-71
OOPS! WE GOOFED!	
VOL. 1, PAGE 61.....	72
VOL. 12, PAGE 28.....	72
VOL. 13, PAGE 27.....	72
VOL. 14, PAGE 22, 41.....	72
VOL. 15, PAGE 63, 65.....	72
INDEX FOR VOLUMES 1 THRU 15.....	73-80

"OOPS! WE GOOFED!" INDEX

<u>ORIGINAL</u>		<u>CORRECTION</u>	
<u>VOLUME</u>	<u>PAGE #</u>	<u>IN VOLUME</u>	<u>PAGE#</u>
1	23	5	18
1	61	16	72
2	20,21	5	18
3	4,7,11,25	5	18
3	25	11	78
3	33	5	18
3	33	10	71
4	5	5	17
4	38	12	66
4	39	13	66
4	45,50	5	17
4	51	9	44
5	19,20	6	25
5	24,28	10	72
5	28	6	25
5	31-34	8	41
5	48	10	72
6	3,12	13	66
6	31-32	7	62-63
6	32	11	78

<u>ORIGINAL</u>		<u>CORRECTION</u>	
<u>VOLUME</u>	<u>PAGE #</u>	<u>IN VOLUME</u>	<u>PAGE #</u>
7	31	8	42
7	37	8	43
7	43	11	78
7	49	10	25
7	53	11	78
7	54	13	66
7	63	11	78
8	16-17	10	72-73
8	17	9	29
8	52	11	78
9	9	10	74
9	29	10	72
9	51	10	75
10	2	11	78
10	10,16	12	66
10	25	13	66
10	28	12	66
10	48	13	67
11	3	12	66
11	4,6	13	67
11	10	12	66
11	11	13	67
11	15,16	12	66
11	41	13	67
11	71	12	66
11	75	13	67
12	7	15	69
12	28	16	72
*12	27	16	72
13	63	15	69
14	12	15	69
14	22,41	16	72
15	63,65	16	72

*Not in Volume 13.



SUPER DIODE PUZZLE CONTEST

TEN WINNERS

ACROSS

1. _____ Madison
2. Snake
5. Current measure
7. Colt
8. _____ Skylark
9. CB and a grape
11. Swedish "import"
14. A representative
15. Not dull
17. What we all need
(Latin)
21. Sphere
23. The dreaded "CB'er"
mechanic
25. Squirrel's goods
26. Also a candy bar
28. Greeting
29. Butter: sub.
31. Tie your hoss' to
this
32. Military bunch, and
MDL 500/C
34. Emer. call
36. A bird?
39. D. T. M^CCall model
by _____
42. Short for company
43. Soda _____
45. North and South poles
46. Norseman, also CB
47. _____ Haw
48. Usual picnic guest

DOWN

1. Named after cats
2. _____ Centurian
3. _____ MDL. SQ-9/-9W
4. Sportscar or
motorcycle
6. Type of pony and CB
10. Singer and MDL
RE-050
12. _____ MDL CB-7000
13. _____ MDL TA-6000
15. Gave us the shasta
16. On the grass in the
a.m.
18. What we could all do
without. "T.R.S. _____"

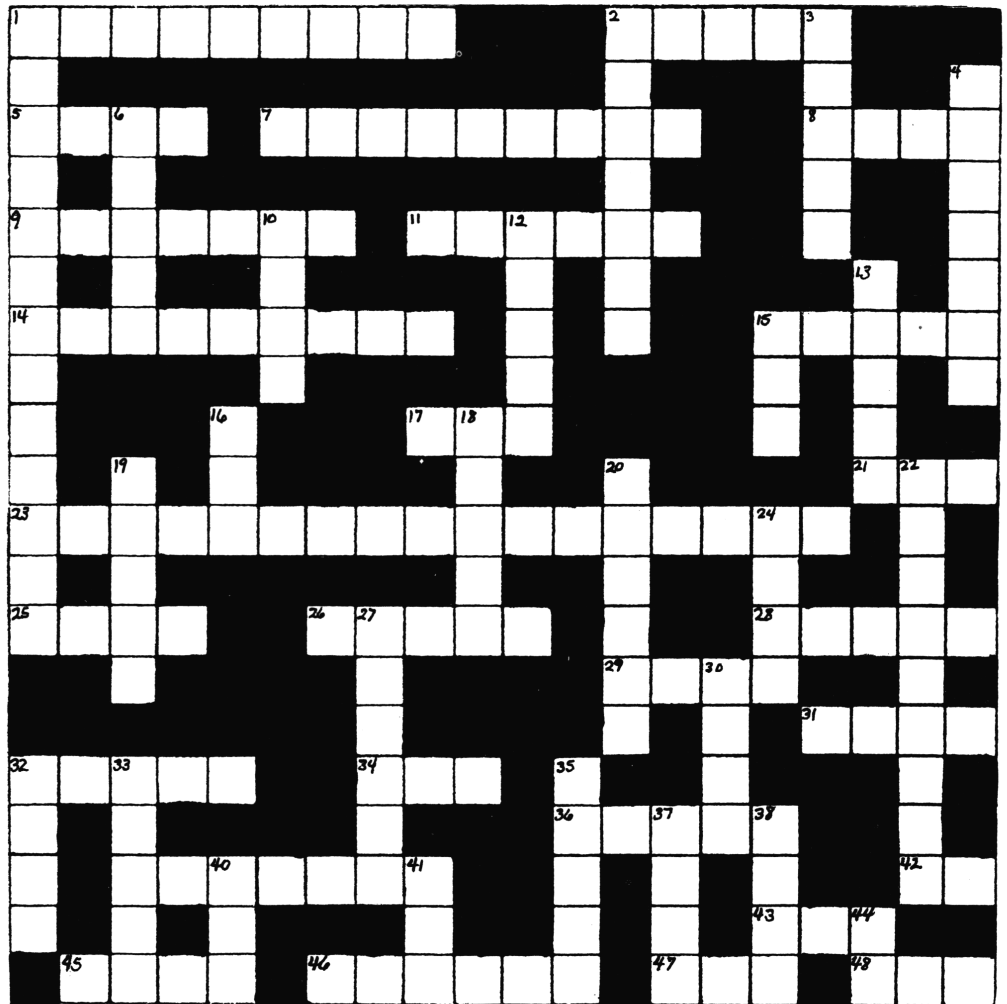

19. A "mean-ie", "bully"
20. Line of trucks
22. R/S brand
24. Repeat of same
27. Genius, with 3rd
grade education
30. Not hard
32. Old car _____
"Classic"
33. _____ Chalet
35. _____ L231, L131
37. Saturday night
chore
38. Opposite of yes
(slang)
40. What most "El Cheapo"
CB's were
41. _____ Mark X
44. _____ Kettle

The first ten correct entries will win one of our famous Super Diodes!

Please send a self addressed, stamped envelope with your entry to Selman Ent., Inc. P.O. Box 8189, Corpus Christi, TX 78412. A Xerox copy of this page is OK.

All entries must be post-marked by Dec. 31, 1983

Answer will be published in Secret CB Volume 18.

Notes

